



Canadian Council of Ministers  
of the Environment    Le Conseil canadien  
des ministres  
de l'environnement

# **PROTOCOLS MANUAL FOR WATER QUALITY SAMPLING IN CANADA**

**PN 1461**

**ISBN 978-1-896997-7-0 PDF**

© Canadian Council of Ministers of the Environment, 2011

<b>1.0</b>	<b>INTRODUCTION.....</b>	<b>1</b>
1.1	WATER QUALITY SAMPLING – IMPORTANCE OF PROPER SAMPLE COLLECTION TO ACHIEVE RESULTS.....	3
1.2	CERTIFICATION AND CHOOSING A LABORATORY .....	5
1.3	QUALITY ASSURANCE/CONTROL IN SAMPLING .....	7
<b>2.0</b>	<b>GENERAL PROTOCOLS FOR SAFETY IN SAMPLING.....</b>	<b>13</b>
2.1	PROTOCOL FOR JOB SAFETY ANALYSIS AND RESPONSE FORMS.....	15
2.2	PROTOCOL FOR SAFETY IN SAMPLING FROM A BRIDGE.....	16
2.3	PROTOCOL FOR SAFETY IN SAMPLING FROM BOATS AND AIRCRAFT .....	18
2.4	PROTOCOL FOR SAFETY IN SAMPLING FROM SHORE.....	20
2.5	PROTOCOL FOR SAFETY IN SAMPLING BY WADING .....	21
2.6	PROTOCOL FOR SAFETY IN SAMPLING THROUGH ICE.....	22
2.7	GENERAL PROTOCOLS FOR SAFETY IN FIELD PRESERVATION OF SAMPLES.....	24
<b>3.0</b>	<b>PROTOCOL FOR CLEANING SAMPLING EQUIPMENT.....</b>	<b>26</b>
<b>4.0</b>	<b>GENERAL PROTOCOLS FOR FIELD NOTES .....</b>	<b>30</b>
4.1	GENERAL PROTOCOLS FOR CHAIN OF CUSTODY.....	32
<b>5.0</b>	<b>GENERAL PROTOCOL FOR FIELD FILTRATION .....</b>	<b>36</b>
5.1	PROTOCOL FOR FILTERING PHOSPHORUS AND NUTRIENT SAMPLES .....	38
5.2	PROTOCOL FOR CONVENTIONAL FIELD MEASUREMENTS .....	40
<b>6.0</b>	<b>PROTOCOL FOR GENERAL SAMPLING METHODS .....</b>	<b>43</b>
6.1	GENERAL PROTOCOLS FOR TAKING SECCHI DISC MEASUREMENTS .....	46
6.2	WATER COLUMN SAMPLING TECHNIQUE PROTOCOLS.....	48
6.2.1	<i>PROTOCOLS FOR SAMPLING THE WATER COLUMN FROM BOATS &amp; AIRCRAFT.....</i>	<i>48</i>
6.2.2	<i>PROTOCOL FOR SAMPLING THE WATER COLUMN FROM BRIDGES.....</i>	<i>49</i>
6.2.3	<i>PROTOCOL FOR SAMPLING THE WATER COLUMN THROUGH ICE.....</i>	<i>51</i>
6.2.4	<i>PROTOCOL FOR SAMPLING THE WATER COLUMN IN LAKES AND STREAMS AT DEPTH.....</i>	<i>53</i>
6.2.5	<i>PROTOCOL FOR SAMPLING FROM SHORE.....</i>	<i>56</i>
6.2.6	<i>PROTOCOL FOR SAMPLING BY WADING.....</i>	<i>57</i>
6.2.7	<i>PROTOCOL FOR SAMPLING WITH USE OF A MULTI- SAMPLER.....</i>	<i>59</i>
6.2.8	<i>PROTOCOL FOR COMPOSITE SAMPLING.....</i>	<i>61</i>
6.2.9	<i>PROTOCOL FOR COLLECTING INTEGRATED AND/OR COMPOSITE INTEGRATED SAMPLES.....</i>	<i>62</i>

6.3	PROTOCOL FOR MONITORING FOR PHYSICAL CHARACTERISTICS, NUTRIENTS, IONS, AND METALS IN GRAB SAMPLES.....	63
6.4	PROTOCOL FOR SURFACE LAYER SAMPLING.....	65
6.5	PROTOCOL FOR AUTOMATED SAMPLING (MULTI-PROBES).....	67
6.6	PROTOCOL FOR BACTERIOLOGICAL SAMPLING.....	72
6.7	GENERAL PROTOCOL FOR COLLECTION OF WATER SAMPLES FOR LABORATORY BIOASSAYS.....	74
6.8	PROTOCOL FOR SAMPLING CHLOROPHYLL-A.....	75
6.9	PROTOCOL FOR SAMPLING MERCURY.....	76
6.10	PROTOCOL FOR MICROBIAL SOURCE TRACKING.....	77
6.10	PROTOCOL FOR MICROBIAL SOURCE TRACKING.....	78
6.11	PROCEDURES FOR PHOTOSYNTHETICALLY-ACTIVE RADIATION (PAR) SENSING.....	79
6.12	PROTOCOL FOR SAMPLING PROTOZOA.....	80
6.13	PROTOCOL FOR TRACE ORGANIC CONTAMINANTS AND PESTICIDES SAMPLING.....	82
6.14	PROTOCOL FOR RADIONUCLIDES SAMPLING.....	86
<b>7.0</b>	<b>PROTOCOLS FOR SEDIMENT MONITORING.....</b>	<b>87</b>
7.1	PROTOCOL FOR SEDIMENT MONITORING FOR NUTRIENTS, METALS AND PHYSICAL CHARACTERISTICS.....	87
7.2	PROTOCOL FOR AIRLIFT SEDIMENT MONITORING.....	92
7.3	PROTOCOL FOR SAMPLING SUSPENDED SEDIMENTS.....	94
7.4	PROTOCOL FOR SEDIMENT OXYGEN DEMAND MONITORING.....	97
<b>8.0</b>	<b>PROTOCOLS FOR SAMPLING FISH.....</b>	<b>100</b>
8.1	PREVENTION OF SPREAD OF AQUATIC INVASIVE SPECIES.....	100
8.2	PROTOCOLS FOR FISH COLLECTION AND PROCESSING TISSUES.....	100
8.3	PROTOCOL FOR SAMPLING FISH WITH GILL NETS.....	101
8.4	PROTOCOL FOR SAMPLING FISH WITH BEACH SEINES.....	104
8.5	PROTOCOL FOR SAMPLING FISH WITH SET LINES.....	106
8.6	PROTOCOL FOR ELECTRO-FISHING SAMPLING.....	107
8.7	PROTOCOL FOR FISH COLLECTION WITH A FYKE NET.....	108
8.8	PROTOCOL FOR MINNOW TRAPS.....	109
8.9	PROTOCOL FOR PROCESSING FISH TISSUES.....	110
8.10	PROTOCOL FOR SAMPLING PARASITES IN FISH.....	112
<b>9.0</b>	<b>PROTOCOLS FOR SAMPLING INVERTEBRATES.....</b>	<b>115</b>
9.1	PREVENTION OF SPREAD OF AQUATIC INVASIVE SPECIES.....	115
9.2	PROTOCOL FOR SAMPLING INVERTEBRATES IN STREAMS.....	115
9.3	PROTOCOL FOR SAMPLING INVERTEBRATES WITH A TRAVELLING KICK AND SWEEP – LAKES.....	117

9.4	PROTOCOL FOR SAMPLING INVERTEBRATES WITH A TRAVELLING KICK AND SWEEP – STREAMS .....	119
9.5	PROTOCOL FOR SAMPLING INVERTEBRATES WITH A DRIFT NET SAMPLER .....	122
9.6	PROTOCOL FOR SAMPLING INVERTEBRATES WITH A SURBER SAMPLER .....	123
9.7	PROTOCOL FOR SAMPLING INVERTEBRATES WITH A HESS SAMPLER.....	124
9.8	PROTOCOL FOR SAMPLING INVERTEBRATES WTH A NEILL SAMPLER .....	125
9.9	PROTOCOL FOR SAMPLING INVERTEBRATES WITH A GRAB SAMPLE.....	128
9.10	PROTOCOL FOR SAMPLING INVERTEBRATES WITH ARTIFICIAL SUBSTRATES.....	129
9.11	PROTOCOL FOR SAMPLING INVERTEBRATES IN WETLANDS .....	130
9.12	PROTOCOL FOR SAMPLING INVERTEBRATES IN SOFT SEDIMENTS.....	132
9.13	PROTOCOL FOR INVERTEBRATE SAMPLE PROCESSING.....	135
9.14	PROTOCOL FOR SAMPLING INVERTEBRATES FOR TISSUE .....	138
9.15	PROTOCOL FOR BIVALVE AND MOLLUSC SAMPLING.....	139
<b>10.0</b>	<b>PROTOCOLS FOR IN-SITU SAMPLING .....</b>	<b>140</b>
10.1	PROTOCOL FOR IN-SITU SALMONID EGG BIOASSAYS.....	140
10.2	PROTOCOL FOR IN-SITU CAGED FISH BIOASSAYS.....	142
<b>11.0</b>	<b>PROTOCOLS FOR SAMPLING MACROPHYTES .....</b>	<b>143</b>
11.1	PROTOCOL FOR SAMPLING MACROPHYTES IN LAKES.....	143
11.2	PROTOCOL FOR MACROPHYTE SURFACE INVENTORY .....	146
11.3	PROTOCOL FOR POINT INTERCEPT MACROPHYTE SURVEYS .....	148
11.4	PROTOCOL FOR LINE INTERCEPT MACROPHYTE SURVEYS .....	149
11.5	PROTOCOL FOR TRANSECT WITH QUADRAT MACROPHYTE SAMPLING.....	151
11.6	PROTOCOL FOR SAMPLING MACROPHYTES IN RIVERS AND STREAMS .....	153
11.7	PROTOCOL FOR MACROPHYTE TAXONOMY .....	155
11.8	PROTOCOL OR MACROPHYTE TISSUE ANALYSIS .....	157
<b>12.0</b>	<b>PROTOCOL FOR BIOFILM SAMPLING.....</b>	<b>158</b>
12.1	PROTOCOL FOR BIOFILM SAMPLING .....	158
12.2	PROTOCOL FOR BIOFILM SAMPLING – SAND-CORING METHOD.....	163
<b>13.0</b>	<b>PROTOCOL FOR PHYTOPLANKTON SAMPLING .....</b>	<b>164</b>
<b>14.0</b>	<b>PROTOCOL FOR SAMPLING MUSSELS FOR METALS AND TRACE ORGANICS .....</b>	<b>166</b>
<b>15.0</b>	<b>PROTOCOL FOR SAMPLING ZOOPLANKTON.....</b>	<b>168</b>

<b>GLOSSARY OF TERMS .....</b>	<b>171</b>
<b>REFERENCES .....</b>	<b>175</b>

## LIST OF FIGURES

Figure 1	Example of filtration apparatus	37
Figure 2	Technique for taking hand-held grab samples	45
Figure 3	Secchi disc measurements	47
Figure 4	Sampling from a bridge	49
Figure 5	Van Dorn depth sampler – horizontal and vertical configuration	55
Figure 6	Procedure for collecting samples	58
Figure 7	Multi-sampler	60
Figure 8	Deployment tubes	71
Figure 9	Assembled protozoan sampling apparatus	81
Figure 10	Kajak-Brinkhurst core sampler	89
Figure 11	Shore-set gill net	103
Figure 12	Seine net	105
Figure 13	Common types of invertebrate samplers	116
Figure 14	Travelling kick-and-sweep method for lakes	118
Figure 15	Travelling kick-and-sweep transect method for wadeable or partially wadeable streams	121
Figure 16	Large river transect kick method	121
Figure 17	Small river transect kick method	121
Figure 18	Grab sampling method for non-wadeable streams	121
Figure 19	Wetland benthos collection methods	131
Figure 20	Samplers used for soft sediments	134
Figure 21	Example of a possible survey pattern for a surface inventory conducted on a small lake	147
Figure 22	Example of use of aquatic macrophyte mapping through time	152
Figure 23	Zooplankton tow net	169
Figure 24	Tow volume calculation	170

Note: Figures redrawn by DoMo Communications Management to ensure consistency of appearance.

## LIST OF PHOTOS

Photo 1	Proficiency testing samples sent to laboratories	6
Photo 2	Accreditation certificates at a laboratory	7
Photo 3	Traffic control safety	17
Photo 4	Handling and preserving of samples using safety gloves	25
Photo 5	Secchi disc	46
Photo 6	Wading and sampling	58
Photo 7	Assembled multi-sampler	60
Photo 8	Use of drum roller	66
Photo 9	A sonde with a number of probes and a wiper	71
Photo 10	Slotted deployment tube	71
Photo 11	ISOMET sampler	77
Photo 12	ISOMET sampler under water	77
Photo 13	Example of a 4-litre sampler	85
Photo 14	Transferring sediment samples to containers	91
Photo 15	Air lift sampler	93
Photo 16	Manual suspended sediment sampler on sampling rod	96
Photo 17	Sediment Oxygen Demand chamber	99
Photo 18	Triangular shaped kick net sampler	120
Photo 19	Kick net transect through a riffle	120
Photo 20	Example of submergent macrophytes	145
Photo 21	Example of floating-leaved macrophytes	145
Photo 22	Example of emergent macrophytes	145
Photo 23	Example of flexible plastic disc	162
Photo 24	Epicollar	162

## LIST OF TABLES

Table 1	– Summary of inter-relationships of some key variables.....	4
Table 2	– Disciplines and matrices available for CALA accreditation.....	6
Table 3	– An example of the level of QA required for one station under the B.C. – Canada Water Quality Monitoring Agreement.....	13
Table 4:	General guidelines for ice strength (clear blue ice).....	23
Table 5:	Summary of macrophyte methods in relation to study objectives.....	143

## HOW TO USE THIS MANUAL

This manual is intended to help users find appropriate protocols that can be used for water quality sampling in Canada. It includes new technologies and methods such as microbial source tracking and continuous water quality monitoring, along with other established methods. The manual covers all aspects of physical, chemical and biological sampling for a variety of aquatic habitats (lakes, rivers, streams, wetlands) and biota (fish, benthos, plankton, etc).

Modifications to jurisdiction specified sampling procedures/protocols should be approved by that jurisdiction before any sampling program is undertaken. Original protocols referenced through out this manual should be consulted in order to obtain more detailed information.

### 1.0 INTRODUCTION

The Canadian Council of Ministers of the Environment (CCME) through the Water Quality Task Group identified a need for water monitoring guidance. This sampling manual will provide a Canada-wide consistency in water monitoring.

In Canada, water quality monitoring and surveillance activities are being conducted by a broad range of practitioners. Federal, provincial, territorial and many municipal governments operate water quality monitoring networks for various reasons, and some of these networks include the collection of other types of samples (e.g., sediments) that maximize the information for the questions that are to be answered by the program. Water quality monitoring programs are often designed to determine if water is of acceptable quality for drinking, swimming, irrigation, or aquatic habitat. This can be assessed using guidelines such as those published through the CCME (1999). Monitoring programs may also be designed to determine if water quality is improving or deteriorating over time, and to identify what is causing the impact and/or deterioration of a river, stream or lake.

In May 2001, CCME Ministers agreed to link existing water quality monitoring networks in order to ensure that Canadians have access to comprehensive information on the quality and safety of water. In response, a Monitoring Sub-Group was formed under the CCME Water Quality Task Group (WQTG) to carry out this task.

In July 2006, the Monitoring Sub-Group of the Water Quality Task Group produced a document titled *A Canada-wide Framework for Water Quality Monitoring*. That report introduced several concepts and information related to water quality monitoring that could lead to Canada-wide consistency, comparability and efficiency. The report recommended the development of several companion technical documents to further this work, including one which describes and catalogues water quality sampling methods.

In early 2008, the WQTG Monitoring Sub-Group completed the first step in developing a Canada-wide guidance manual on water quality sampling, which was to inventory all of

the existing sampling protocols and methods being employed by federal, provincial and territorial jurisdictions.

The objectives for this sampling manual are to provide users with:

- An integrated guidance manual of sampling protocols for water quality monitoring in Canada in order to increase consistency across Canada;
- An understanding of the main principles of ambient fresh water quality monitoring of lakes and streams, including collection of representative samples for each case so that scientific judgment can be applied for certain monitoring programs where it may not be appropriate (due to logistics, use of certain laboratories, or where a program has different objectives, etc.) to follow all aspects of certain protocols;
- An understanding of why different sensors are used in monitoring, and the need for proper calibration of each; and
- The ability to apply the understanding gained through the theoretical discussion and the practical real-life examples to sampling streams and lakes in a safe and accurate manner.



## 1.1 WATER QUALITY SAMPLING – IMPORTANCE OF PROPER SAMPLE COLLECTION TO ACHIEVE RESULTS

When gathering ambient water quality samples, it is crucial that samples be collected in a consistent and proper manner with the appropriate equipment, so the analytical results or field measurements will reflect the environmental conditions at the time of sampling.

There is the potential during any sampling effort, to inadvertently generate sampling errors. They may be themselves minute in nature. However, several errors can combine into one significant error from any one sample collection. This can lead to poor samples collected, money wasted to test the poor samples, erroneous results generated, and lead to poor conclusions derived.

### Inter-relationships of Different Variables

When testing water quality in an ambient sample, there is a wide array of potential assays from which to choose, and many provide the same information. In other situations, in order to fully understand the significance of one variable, it may be necessary to test a variety of variables this can maximize the interpretation of the data. This section will describe several of these variables.

#### **Parameters measured in-situ**

Specific variables should be tested in the field, this can be completed by using a hand-held meter or any other additional field technology. Specific variables can also be tested in a laboratory environment with the correct equipment. The purpose of the apparent duplication is that there is potential for the sample to change state during transport from the field to the laboratory.

The *sample temperature* should be collected immediately from a standalone sample, no other variables should be tested from this sample. *Dissolved oxygen* concentrations may be tested by either an appropriate DO meter or by using the laboratory process, the Winkler titration. *pH* and *specific conductivity* should be measured in the field to capture any sample change during transportation to the laboratory. *Turbidity* is frequently measured in the field, this can be achieved through a continuous process throughout the sampling period.

#### **Parameters measured in laboratories**

Laboratories can provide additional testing methods for samples. This allows several types of parameters to be analyzed in a sample. Generally, the analysis includes what are deemed as conventional parameters (pH, specific conductivity, hardness, and turbidity), solids (total, suspended, dissolved, inorganic, and organic), nutrients (such as different forms of nitrogen, phosphorus, and carbon), metals (measured as total, dissolved, or extractable), pesticides, and more complex organic compounds such as PCBs, PAHs, dioxins and furans, and many others. For a detailed description of standard analytical methods for these parameters see Eaton *et al.* (2005).

Variable (s)	Second Variable (s)	Relationship
Specific Conductivity (SC)	Dissolved Solids (TDS)	SC and TDS are usually related for each water body. TDS is the sum of constituents such as chloride, sulphate, etc.
Turbidity	Suspended Solids (TSS)	Turbidity can be related to the amount of solids in suspension
Temperature	Dissolved Oxygen	The amount of oxygen in water increases with cooler temperatures.
pH and Temperature	Ammonia	The toxicity of ammonia in water increases with higher pH and temperatures
Secchi Disc Reading	Turbidity, colour, algae	Measures light penetration in a lake that is reduced by these three factors
Chloride	Nitrite	The toxicity of nitrite in water decreases with increased chloride
Hardness	Alkalinity	Alkalinity and hardness often have similar concentrations in water
Hardness, Dissolved Organic Carbon (DOC)	Metals	The toxicity of some metals (e.g., copper, zinc) decreases with increasing hardness and DOC

**Table 1 – Summary of inter-relationships of some key variables**

As mentioned, variables such as *pH*, *specific conductivity*, and *turbidity* should be measured in the field and again upon receipt in the laboratory, this will determine whether the sample has changed during transport. It is usual for the laboratory to measure the *temperature of a sample upon arrival*. Temperature is an excellent indicator to identify if the samples have been shipped correctly (i.e. with enough ice for ambient air conditions). Samples collected during the winter months will naturally be at a lower temperature to start and generally will not require the same amount of packaging as samples collected during summer months. Care should be taken when packaging samples in winter months in ensuring that the sample containers do not freeze and rupture, in turn destroying the integrity of the sample. In cases where temperatures are expected to be below freezing, collapsible jugs of warm water should be added to the packaging in order to prevent samples from freezing and possibly breaking in transport. This is particularly important when samples are shipped as cargo by bus or plane.

### *Sample hold times*

Each parameter has a specific hold time that ensures the results generated are accurate. If this maximum time frame (i.e. hours or days) has passed, the data generated through sample analysis should not be used since its accuracy cannot be confirmed. Some variables must be analyzed within 48 or 72 hours from the time of collection (referred to

as holding time) It is essential that samples be shipped to the laboratory as soon as possible. It is important to avoid a lengthy time delay before laboratory analysis. It may be necessary to ship the sample on the same day as collection to preserve the variables. It is the responsibility of the sampler to determine which variables are time sensitive and ensure the hold times are met. When shipping samples, aim to maintain the shipment temperature between 10°C and 4°C, temperature ranges may require adjustment with specific sample parameters. Temperature control for shipping during warmer months can be through ice packs placed in the coolers. During winter months care (i.e. heat packs) should be taken to prevent freezing of the samples.

#### *Description of key variables*

It should be noted that *specific conductivity* is often used as a surrogate measurement for *dissolved solids*. The actual relationship between these two variables will be site specific and based on the water body. Both specific conductivity and dissolved solids provide a measure of the contribution of different salts that may be present in the sample; this may include *potassium, sodium, chloride, sulphate* and others.

Turbidity is a measure of the light penetration in the sample. The turbidity of the sample depends on the size and distribution of the suspended solids in a sample. Turbidity and specific conductivity can provide estimates of the amounts of suspended or dissolved solids that may be present, however they can not be used as absolute replacement measurements for the more specific test. For sites with sufficient enough data, it is possible to identify a significant site specific relationship between turbidity and total suspended solids. The relationship should be reviewed overtime as the water body changes. Understanding the connection between turbidity and total suspended solids is important. If turbidity is a known variable and TSS is unknown, one can calculate the existence of the TSS using the turbidity levels.

Other tests require accompanying measures of other variables. When *metals* are measured, interpreting the results sometimes requires knowledge of the *hardness* and/or the *organic carbon* concentration in the sample. The toxicity of some metals is reduced with increasing hardness or organic carbon concentrations.

To interpret the impact that *ammonia* might have in a water body, knowledge of the *pH* and *temperature* is also necessary. The toxicity of ammonia decreases at lower temperatures and pH values, therefore these variables must be measured and recorded. Similarly, the impact of *nitrite* is ameliorated at higher concentrations of *chloride*.

## 1.2 CERTIFICATION AND CHOOSING A LABORATORY

In Canada, laboratories can enter voluntary certification programs that can provide proof of competency in the analysis of parameters of concern. In Canada, the major provider of such services is the Canadian Association for Laboratory Accreditation (CALA). Some provinces such as Quebec have a separate accreditation program. The goal of CALA is to help laboratories achieve and demonstrate the highest levels of scientific and management excellence through the combined principles of competence, consistency, credibility and communication. The advantages to a person conducting analytical

monitoring in using a laboratory that has been accredited by CALA is that they can be confident that the laboratory has the ability to provide accurate and precise analytical measurements.

Laboratories receive accreditation on a test-by-test basis for specific matrices (e.g., ambient waters, wastewaters, etc.). What this means is that a laboratory may receive accreditation for the performance of one test (for example, copper) in one media but might not have accreditation for another test (for example, zinc) in the same or different media. The reason for this is that first, the laboratory must apply for accreditation in each test, and, second, they may not meet the standards that are applied by the accrediting agency. Therefore, when selecting a laboratory for testing, you must ensure that they have accreditation in the media and for the parameters that you are interested in.

Generally, all organizations that grant accreditation for testing require that laboratories illustrate proficiency by undertaking proficiency testing. Proficiency testing is defined as the use of inter-laboratory comparisons to determine the performance of individual laboratories for specific tests or measurements.



Photo 1. Proficiency testing samples sent to laboratories (Courtesy: L. Swain, Tri-Star Environmental Consulting)

Disciplines	Matrices
inorganic chemistry	water, waste oil, soil/sediment, air collection media (e.g. quartz and cellulose acetate filters, and charcoal tubes) and asbestos testing
organic chemistry	water, waste oil, soil/sediment, air collection media (e.g. quartz and cellulose acetate filters, and charcoal tubes) and asbestos testing
toxicology	water, waste oil, soil/sediment
occupational health	air collection media (e.g. quartz and cellulose acetate filters, and charcoal tubes) and asbestos testing
microbiology	Water, soil/sediment

**Table 2 – Disciplines and matrices available for CALA accreditation<sup>1</sup>**

<sup>1</sup> <http://www.cala.ca/index.html>

For CALA, the Proficiency Testing (PT) Program targets high volume testing in the disciplines of inorganic chemistry, organic chemistry, toxicology, occupational health and microbiology for the following matrices: water, waste oil, soil/sediment, air collection media (e.g. quartz and cellulose acetate filters, and charcoal tubes) and asbestos testing. CALA indicates that a laboratory has acceptable performance for a test should the PT score  $\geq 70$ . If scores less than 70 are attained, then the following consequences result:

- one non acceptable result = possible suspension (PS) of accreditation
- two successive non-acceptable result = suspension (S) of accreditation
- three successive non-acceptable result = withdrawal (W) of accreditation

Laboratories often offer “package” tests for certain matrices, such as metals and pesticides, and care must be taken in choosing the method. For a detailed discussion of standard analytical methods see Eaton *et al.* 2005. In selecting a method, consideration must be given to the detection limit of the method in question and the corresponding water quality guideline against which the data may be assessed. In general, detection limits should be five to ten times lower than the guideline that will be used for comparison, and/or the levels being measured, in order to ensure that there are no false-positive values. Some laboratories are better suited for analyzing ambient samples and this can be determined from their PT studies.



Photo 2. Accreditation certificates at a laboratory  
(Courtesy: L. Swain, Tri-Star Environmental Consulting)

### 1.3 QUALITY ASSURANCE/CONTROL IN SAMPLING

Improper sampling techniques can lead to non-representative test results, which do not represent the media/matrix being sampled. Improper sampling techniques can lead to erroneous conclusions and management actions. Non-representative test results are also

possible if adequate care and control is not taken during collection of the sample or the laboratory analysis of the sample.

A field quality assurance program is a systematic process, and together with a laboratory and data storage quality assurance program, ensures a specified degree of confidence in the data collected for an environmental survey.

The first step in ensuring proper sampling techniques is to provide staff with training for the sampling conditions they encounter. A sampling plan should also be established for each program or investigation. The sampling plan should outline such items as:

- when samples are to be collected (weekly, bi-weekly, monthly, quarterly, etc),
- where samples are to be collected,
- types of sample collection devices and containers to be used,
- what types of samples are to be collected at each site,
- which method to use,
- how these samples should be preserved,
- which field measurements (and notes) are to be made, and
- which laboratories the samples are to be shipped to.

Hard copies of sampling plans should be carried into the field with the contact name and information of the principal investigator to be contacted should questions arise in the field. A sampling plan ensures that all data are collected to the same standard using the same protocols. A sampling plan should contain enough detail for substitute field personnel to carry out the program/survey/investigation.

Sample bottles should be kept in a clean environment, away from dust, dirt, fumes and grime. As well, bottles must be capped at all times and stored in clean shipping containers (coolers) both before and after the collection of the sample. Vehicle cleanliness is an important factor in eliminating contamination problems (RISC 1994).

As stated previously samples must never be permitted to get warm and should be stored in a cool, dark place. Most samples must be cooled to 4 to 10°C during transit to the laboratory; ensure copious quantities of ice packs or dry ice are used to keep samples cool. Samples should be cooled as quickly as possible in order to reduce biological and chemical activity in the sample. Alternatively, during colder months, precautions must be taken to prevent samples from freezing. Collapsible jugs of warm water should be added to shipping containers to ensure the samples remain between 4 and 10 °C.

Sample collectors should keep their hands clean, wear gloves when sampling and refrain from eating or smoking while working with water samples. Exhaust fumes and cigarette smoke can contaminate samples with lead and other heavy metals. Air conditioning units are also a source of trace metal contamination.

Van Dorn bottles, dissolved oxygen samplers for grab samples and composite samplers need to be properly washed and rinsed. Hoses for composite samplers need to be cleaned as well since residual quantities can accumulate if the hoses are not properly maintained.

Field measurements should always be made *in-situ* or using a separate sub-sample, which is then discarded once the measurements have been made. They should never be made on a water sample that is returned to the analytical laboratory for further chemical analyses. For example, specific conductivity should never be measured in sample water that was first used for pH measurements. Potassium chloride diffusing from the pH probe alters the conductivity of the sample. Similarly, pH should not be measured from a sample that will be analyzed for phosphorus, as some pH buffers contain phosphorus. Use a separate bottle for water temperature if not *in-situ*. Dissolved oxygen measurements (by DO probe) should be made *in-situ* rather than in a separate container (Resource Inventory Standards Committee (RISC), 1994)

Often, sample containers provided by the laboratory for analyses will be “certified” as being contaminant-free. In some situations upon the advice from the laboratory, sample bottles need not be rinsed with the sample water being collected. Bottles must be supplied with cap in place. Cleaned re-used bottles are not suitable for some trace constituents.

### **Types of Water Quality Sampling Quality Assurance/Quality Control (QA/QC) Samples**

Quality control samples are used to verify the integrity of water samples. For example, blank samples (generally de-ionized water) can be used to determine if contamination might enter a water sample in the transport (trip blank) or the entire sampling process (field blank). **Blank** samples are used:

- 1) to test the purity of chemical preservatives;
- 2) to check for contamination of sample containers, filter papers, filtering equipment or any other equipment that is used in sample collection, handling or transportation;
- 3) to detect contamination that occurs during sampling, and
- 4) to detect other systematic and random errors occurring from the time of the sampling to the time of analysis.

**Trip blanks** are usually prepared in the laboratory and simply travel with the sample bottles from the laboratory to the sampler, to the sample site, and then back to the laboratory without ever being opened. These trip blanks indicate contamination within the bottle or from volatile compounds. Alberta Environment (2006b) recommends one per trip.

In contrast, a **field blank sample** is prepared in the same manner as a trip blank and makes the journey as a trip blank; however, the difference arises when sampling occurs. During the sampling process, the field blank sample is opened and the collection process is mimicked. These measure contamination from bottles, collection methods, the atmosphere, and preservatives. Alberta Environment (2006) recommends one for every ten regular samples. B.C. Environment (2003) recommends a minimum of one field blank per sample set, or one field blank per day per collection apparatus. A practical approach is to take a full suite of blanks but only initially analyze the field blanks. If the field blanks don't indicate problems, the other blanks (e.g. travel, filtration, equipment) may be discarded or stored.

**Filtration blanks** should be used regularly or as a minimum, when contamination is suspected. These measure contamination from the filters, and the filtration apparatus.

**Bottle blanks** measure contamination from improper cleaning of bottles. Both filtration and bottle blanks should only be used on an as-needed basis.

In addition, more than one sample may be collected from the same sampling device (**replicate sample**) at the same time as the original sample to determine the precision (how close the results are to each other) of tests. Field replicates provide precision of field plus laboratory plus environmental heterogeneity. Environmental heterogeneity can be eliminated by collecting one sample which is then split. In some cases, it may be impossible to collect replicate samples at exactly the same time as the original sample. In such cases, these replicates are deemed to be co-located samples. For a true estimate of precision, the co-located samples should be submitted at separate time intervals (if possible in time period). Generally, one duplicate should be collected per sample set (BC Environment 2003) or for every ten regular samples (Alberta Environment (2006b)).

Finally, **standard reference materials** or samples (where the actual value has been certified independently) are used to determine if the results are accurate (close to the true value). These are not often used by field staff; however, these can be used when special circumstances dictate (e.g., use of a new laboratory where one is uncertain of its analytical capabilities, beginning of the field season, new project, etc.). Values should be within the certified ranges for the standard reference material.

Typically the total number of QA/QC samples should represent a minimum of 10% of the total number of samples (Alberta Environment (2006b)) although others suggest higher levels in the order of 20%. They should include at a minimum, the collection and analysis of field duplicate samples and split samples. QA/QC samples may also include equipment blanks, field blanks, triplicate samples and field spikes.

The test laboratory itself usually will have similar processes in-place to ensure that results that were reported can be reproduced. These will include training plans for staff, analysis plans for each analyte to be tested, quality control samples to ensure that there is no contamination (analysis blanks) occurring in the laboratory, that the results are precise (replicates), and that the results are accurate (use of standard reference materials and percent recoveries). The amount of quality assurance provided by any laboratory should be available upon request. As well, the results of quality control samples analyzed at the same time as your samples should be available and should be obtained in order that the results can be interpreted later.

The initial amount of samples allocated to QA/QC depends on:

1. **Level of experience of the field staff and familiarity with the analyzing laboratory.** When both the laboratory and field staff are unfamiliar with the design of the program, funds directed towards QA/QC should be divided equally between the two. On the other hand, if either has demonstrated consistency and reliability in the past, then funding requirements can be decreased for that component.



2. **The type of program.** Impact assessment and survey (or baseline) monitoring generally require more QA/QC funds than compliance and trend monitoring. Compliance monitoring is usually conducted as an extension of an existing monitoring program so that previous QA/QC efforts likely have established a satisfactory degree of accuracy and precision. For trend monitoring, there usually is more consistency in the field, personnel, and laboratory analytical techniques. Personnel and equipment techniques will be used at the same locations on a regular schedule during an extended period of time.
3. **State of water quality.** There is no need to invest significant funds for QA/QC when the values obtained for particular variables are consistently well above the minimum detectable limit (MDL). When values are well above the MDL, a false positive is highly unlikely, and therefore the funds might be of better use if directed elsewhere (e.g., towards more frequent monitoring). When values are well below the level of concern for protection of the designated water, a portion of the budget might be of better use when allocated to a separate program (i.e., a different watershed that is of higher priority).

## **Types of Biological QA/QC Samples**

**Replicate Samples:** Biological replicate samples can consist of multiple samples (grabs, tows, or whole fish) from the same general area (to measure how well a single sample represents the community or how many samples are necessary to achieve some level of sampling confidence), or portions of a single sample (i.e., sectioned grabs - to measure more localized invertebrate heterogeneity).

**Split Samples:** Split samples are aliquots taken from the same container and assumed to be identical. These samples can be sent to two or more laboratories for separate analysis and the results can be used to determine inter-laboratory variability or the consistency of results within one laboratory.

**Reference Samples:** Laboratory-tested and preserved reference materials are available for tissue samples. For example, the National Research Council of Canada (NRC) has dogfish liver and muscle tissue and lobster hepatopancreas tissue for the determination of trace elements and organo-mercury. These reference tissues have been subjected to a large number of analyses performed by independent laboratories using several different analytical techniques. Consequently, the NRC provides mean values and confidence intervals for these substances. Other reference tissues are available from other sources.

**Taxonomy Samples:** Basic taxonomic reference materials are available for taxonomy samples. The US EPA is a source for taxonomy samples in reference to algal taxonomy, chlorophyll-a and several bacterial species. These reference samples should be submitted to the analyzing laboratory along with the samples collected during a field trip. They should be transferred to a regular sample container and labeled with plausible site names and numbers (the codes used for identification must be documented in the field logbook).

As well, taxonomic reference materials can be created for various regions by generating a 'reference collection' or 'voucher specimen' collection that has been independently

verified by an external expert. There should be a minimum number of samples from the survey/study that are re-counted and re-identified by a second taxonomist to get an estimate of identification error and count error.

## Understanding QA Results

The QA data results should be evaluated for completeness. This includes providing a summary of the planned and actual QA procedures undertaken and a summary of the metadata on a variable-by-variable basis to indicate the success in obtaining and storing the data. This requires verification of a minimum of 10% of the laboratory results received via electronic transfer with results forwarded separately, usually in hard copy, within seven days of receiving the analytical results.

It should be determined if contamination is present in the samples. The general rule of thumb is that levels are acceptable if there are less than or equal to 5% of *blanks* with values greater than the detection limit (network-wide).

Precision is deemed to be acceptable if there is <25% relative difference or <18% coefficient of variation, when the mean of the *replicates* is  $\geq 10$  MDL, and results are  $\geq 10$  MDL if the analytical methods are different. The Relative % Difference is defined as:

$$\text{Relative \% difference} = \frac{(S_2 - S_1)}{[(S_1 + S_2)/2]} * 100\%$$

where  $S_1$  and  $S_2$  are the sample results

and for triplicates (or greater) use Relative Standard Deviation (RSD):

$$\text{RSD} = \text{SD}/(S_1 + S_2 \dots + S_n)/n$$

where  $S_1$ ,  $S_2$  and  $S_n$  are the sample results  
and SD is the standard deviation

The coefficient of variation is defined as:

$$\text{Coefficient of variation} = \frac{\text{SD}}{[(S_1 + S_2)/2]}$$

where  $S_1$ , and  $S_2$  are the sample results  
and SD is the standard deviation

Detection Levels are considered to be good if  $\geq 50\%$  of values  $\geq 3$  MDL and  $\text{MDL} \leq 0.1$  of the lowest relevant water quality objective or guideline.

An example of the QA used in the Canada - British Columbia Water Quality Monitoring Agreement is shown below for one station (Table 3). It should be noted that 30 samples ( $26 + 2*2$ ) are to be collected at the station each year, and that there are six rounds of QA samples submitted. This is a minimum 20% level of QA consisting of field replicates and field blanks (including filtration blanks and replicates where appropriate).

Variable	Annual Frequency	QA Frequency
Alkalinity	26	6
Metals Trace	26	6
pH	26	6
Temperature	26	6
Turbidity	26	6

**Table 3 – An example of the level of QA required for one station under the B.C. – Canada Water Quality Monitoring Agreement**

## 2.0 GENERAL PROTOCOLS FOR SAFETY IN SAMPLING

### Overview

It is crucial that samples are collected in a safe manner. This includes having first aid equipment, communication equipment, survival gear, wearing proper footwear, gloves, life jackets or flotation devices, reflective jackets, and personal safety devices for confined entry situations. It also means that samples usually are collected by teams of two individuals, one of whom is the support person who can provide help to the other should the sampler encounter an unsafe situation from which they cannot remove themselves. The field crew must be trained for the situations to be encountered; experienced with the proposed program and the potential hazards; a detailed job safety analysis must be prepared, this should include very specific emergency response plans; and the crew must be aware of any special safety considerations. Basic information is provided here.

### Sources

Environment Canada and B.C. WLAP (2005 (c)), Alberta Environment (2006), Environment Canada (2006 b), Environment Canada (2007)

### At a glance

*gloves as protection*

- 1** Samples should be collected using latex or plastic gloves in order to protect the sampler from contaminants in the ambient waters, and from coming into contact with preservatives.
- 2** At a minimum, all field crew members should possess valid

*training* Standard First Aid (Level 1), CPR and Workplace Hazardous Materials Information System (WHMIS) certification to ensure individual and crew safety. Additional required training could also include Transportation of Dangerous Goods (TDG), small boat safety (as required by the Coast Guard), swift water safety and awareness, ice safety and awareness, defensive driving, all-terrain vehicle safety, snowmobile safety, bear awareness, and wilderness first aid.

*workers being informed* **3** Provincial Workplace Hazardous Materials Information System (WHMIS) legislation requires that all workers be provided with information concerning the storage, handling and use of controlled products. This includes materials such as chemical preservatives. WHMIS requires that controlled products are labeled so that workers are alerted to the identity and dangers of products and to basic safety precautions. In addition, material safety data sheets (MSDS) are to be provided. These are technical bulletins that provide detailed hazard-precautionary and first aid treatment information for controlled substances, as well as the hazardous ingredients, physical data, fire and explosion hazard, reactivity data, health effects, preventative measures, first aid measures and preparation information. All sample collectors should obtain copies of current MSDS sheets for each preservative that they are expected to use and become familiar with the sheets.

*danger from complacency* **4** Individuals involved in sampling ambient waters should never become complacent about the potential dangers that exist in this occupation. Although we may think about such dangers as a thing of the past, there is a large volume of evidence that such tragedies continue to this day. There are too often injuries and deaths attributed to poor judgment even when samplers have been to a site numerous times before. At each site the field team should do a quick site safety assessment prior to carrying out any work (i.e. assess site location and access hazards, potential upstream, in-stream, and downstream hazards, safety gear required, etc.)

## 2.1 PROTOCOL FOR JOB SAFETY ANALYSIS AND RESPONSE FORMS

### Overview

To ensure the safety of field staff, a job safety analysis (JSA) is a very important component of any work plan. The JSA identifies what work will take place, lists all of the potential hazards that could be encountered during the work, and details the measures necessary to avoid or mitigate the hazards. All staff undertaking sampling duties should be properly trained for the situations that they may encounter (driving trucks, handling boats, sampling on ice, cold weather survival training including hypothermia and heat stress, first-aid, etc.) and be supervised.

### Sources

Environment Canada and B.C. WLAP (2005 (c)), Alberta Environment (2006), Environment Canada (2006 (b)), Environment Canada (2007)

### At a glance

**1** The JSA includes a list of the personal protection equipment required for each component of the field sampling such as driving to the worksite, ATV loading/unloading and access to remote sites, boat loading/unloading and operation, and specific sampling methods.

*emergency  
response  
plan*

**2** An additional component of the JSA is an emergency response plan (ERP), which contains all of the necessary information should an emergency situation arise. This includes contact numbers for all persons involved with the project, local emergency contact numbers (EMS, police, fire), hospital contact numbers and evacuation route(s), and any other information necessary for an emergency situation. Field operators are encouraged to report and rectify any safety issues that they encounter in the course of their normal duties. In the event of an injury, field operators must fill in the appropriate accident reporting form for their jurisdiction.

*daily  
check-in  
time*

**3** A component of the ERP is a check-in time where the field crew will check in with a project manager on a daily basis to confirm their safety and the progress of the work. If this contact is not made, the project manager would initiate emergency measures.

*daily  
meetings*

**4** Daily meetings should be held to detail the work to be completed during the course of the day and allow the opportunity for all crew members to discuss any issues, concerns or improvements to the safety of the sampling program.

## 2.2 PROTOCOL FOR SAFETY IN SAMPLING FROM A BRIDGE

### Overview

When sampling from a bridge, traffic may present serious problems either by being in close proximity to you as you sample or when your vehicle is parked either on the road shoulder or encroaching onto the roadway. For this reason you should try to adjust sampling times in order to avoid busy traffic. You should wear a reflective vest and use a pedestrian walkway if it is available. Some large trucks travel at great speeds over bridges, especially if the bridge is located at the bottom of a steep hill. The wind from these vehicles can make you lose your footing and also blow bottles and caps over the edge of the bridge. Dust stirred up by any vehicle can also contaminate water samples when they are uncapped.

### Sources

Environment Canada and B.C. WLAP (2005 c), Environment Canada (1999 Draft), Environment Canada (2005 b)

### At a glance

*check  
visibility*

**1** Special care must be taken when sampling from bridges over navigable water, as boat operators and water skiers may not be able to see the sampler ropes. It may be necessary to flag equipment so that it is easily visible.

**2** Power lines strung along or close to bridges should also be respected and avoided. At no time should the rope attached to a multi-sampler be draped over a power or telephone line.

**3** Certain jurisdictions may require a permit if a person is working or parking on the side of a highway or street for more than 30 minutes. The need for a permit should not be a problem in most circumstances.

*park with  
care*

**4** If you park on the highway shoulder, hazard lights (and roto-beacon if available) and traffic cones must be used to alert oncoming traffic of your presence (Photo 3). If your vehicle encroaches onto the road, two crew working signs, hazard lights, a circular light and three to six pylons should be used to alert oncoming traffic of your presence.

**5** Whenever possible park your vehicle so as not to obstruct traffic. If you are encroaching into bridge traffic, a minimum of three traffic pylons must be used to mark out your work area on the bridge. Two crew working signs must also be used at either end of the bridge to signal to oncoming traffic that you are working on the bridge.

*reflective  
vest*

**6** Samplers must wear a reflective safety vest to ensure being clearly visible to oncoming traffic.

**7** Assess the bridge deck for slip/trip hazards and wear appropriate footwear. If sampling from a bridge with a wooden

*be aware of footing* walkway, ensure that the boards have not begun to rot or that there are not missing planks or holes present. Ensure that the bridge railing is secure. Do not lean over the bridge railing.



Photo 3. Traffic control safety  
(Source: Environment Canada and B.C. WLAP (2005))

## 2.3 PROTOCOL FOR SAFETY IN SAMPLING FROM BOATS AND AIRCRAFT

### Overview

When sampling from aircraft, the pilot has final say regarding operational details such as loading of equipment, weather conditions under which the trip can be performed safely, safety information and deplaning procedures. A personal flotation device (PFD) should always be used. When sampling from a boat or aircraft, you should perform a visual inspection of the surroundings paying close attention to wave height and direction. Individuals should move within the boat using slow, calculating motions, thereby minimizing risk and should not stand in the boat to obtain the water sample. The boat must be maintained in a safe condition and aircraft safety and maintenance records should be inspected.

### Sources

Alberta Environment (2006 a), Environment Canada (1999 Draft), Environment Canada (2001), EMAN-N (2005)

### At a glance

- boat and aircraft positioning*
- 1** Prior to collecting a sample, it must be ensured that the anchor is secure and the boat is pointed into the wind. For aircraft, it must be ensured that the rotors and engines are still and the aircraft is pointed into the wind. Do not go forward from the red line on the float.
- boat safety*
- 2** When sampling from a boat, be aware of other boat traffic and natural hazards. All power-driven vessels must yield the right-of-way to those not operating under power such as canoes. Two paddles, a bailer and an anchor must be on board. All Transport Canada regulations regarding equipment required relative to the type/size of boat being used should be adhered to.
- moving within the boat*
- 3** Samplers should position themselves securely on the floor of the boat or on one of the seats. Move within the boat using slow, calculating motions, thereby minimizing risk to oneself as well as others in the boat. Do not stand in the boat to obtain the water sample. Position yourself securely on the floor of the boat or on one of the seats. Prior to collecting a sample, the other crew members in the boat should be informed that a sample is going to be collected and they should counter balance the boat by positioning themselves on the opposite side to which the sample will be collected.
- link between pilot and sampler*
- 4** The rear door of fixed-wing aircraft (e.g., the Cessna 206, with its long, broad tail section) should be tied open. Direct or headphone communication with the pilot is essential. The pilot may need to communicate the difficulty of keeping the aircraft stable on the water, or the fact that wind, wave or fog conditions are making it too dangerous to continue with the sampling. It is much safer to have a third person to help with communication



between the sampler and the pilot. Relatively busy “air traffic” in popular lake areas may mean additional safety risks, forcing workers to work quickly and efficiently.

*footing on  
pontoons*

**5** Ensure that footing is secure on aircraft if sampling from pontoons. Pontoons become wet and possibly slippery when landing. Samplers on pontoons should be tethered to the aircraft and should be wearing a PFD as well as rubber boots. The PFD should not be worn in the aircraft unless it is the manual inflation type.

*leaving a  
helicopter*

**6** For helicopters, never leave from the rear of the helicopter as the tail rotors are dangerous. If it is absolutely necessary to depart a helicopter with the engine running such as during winter sampling, leave the helicopter in a crouched position.

**7** After the sample has been collected, the crew members should return to their regular positions in the boat or aircraft.

## 2.4 PROTOCOL FOR SAFETY IN SAMPLING FROM SHORE

<b>Overview</b>	Sampling from shore is one of the easiest methods for collecting samples, but it can also be dangerous. Always wear a PFD. Secure footing is essential and at swift water locations it is advisable to be tethered (to either a tree or a second person should policy so require) in case one slips into the current.
<b>Sources</b>	Environment Canada and B.C. WLAP (2005 c), EMAN-N (2005), Environment Canada (2005 a)
<b>At a glance</b>	<ol style="list-style-type: none"><li><b>1</b> When sampling from shore, a personal flotation device (PFD) must be worn.</li><li><b>2</b> You should ensure safe footing and be well balanced (the current may pull a multi-sampler unit sharply downstream). If <i>safe footing</i> rocky outcrops exist, ensure that these are not slippery when sampling.</li><li><b>3</b> If safety is a concern at the site, samplers must attend a <i>Swift-water Safety and Awareness course</i> provided by Rescue Canada or other certified agency.</li><li><b>4</b> If you are not certain that river conditions are safe, you <i>do not take risks</i> should not take a sample. Never take unnecessary risks.</li></ol>
<b>Other sources</b>	Environment Canada Undated (a), Newfoundland and Labrador Environment and Conservation (1999), Environment Canada (1999) draft, NB 2000, Saskatchewan (Undated), Environment Canada 2003 (g)

## 2.5 PROTOCOL FOR SAFETY IN SAMPLING BY WADING

### Overview

Wading is one of the easiest methods for collecting samples, but it can also be one of the most dangerous. Rubber boots or hip-waders are standard equipment. If chest waders are worn a compression belt (or closely-fitted PFD) should be used. A wading rod or similar probing instrument is often useful to estimate the current and to locate holes and unsafe footing.

### Sources

Environment Canada and B.C. WLAP (2005 c), EMAN-N (2005), Environment Canada (2005 a)

### At a glance

- 1** When sampling by wading, a personal flotation device must be worn.
- necessary training* **2** If swift water safety issues have been identified at the site, then the sample collector must be tethered and the second crew member must have a throw-bag. The sampler must participate in a *Swift-water Safety Awareness training course* provided by Rescue Canada or other certified agency.
- be aware of conditions before sampling* **3** Explore the streambed for large obstacles or holes if you don't know the stream to be sampled or if the streambed changes at times. Wade carefully into the stream with a wading stick and safety line. Once you are certain that it is safe, sampling can begin.
- 4** Be aware of large ice pans that could knock you off balance or trap you. Also be aware of ice formation on rocks and other surfaces.
- 6** If the river is too high and/or swift for wading, then the samples should be collected from a nearby safe shore location.
- 7** If you are not certain that river conditions are safe, you should not take a sample. Never take unnecessary risks.

### Other sources

Environment Canada (1999 Draft), New Brunswick 2000, Saskatchewan (Undated), Environment Canada 2003 (g)

## 2.6 PROTOCOL FOR SAFETY IN SAMPLING THROUGH ICE

### Overview

When sampling on ice, always proceed with caution and do not jeopardize your safety. You should test the ice thickness with a rod or ice chisel every few steps. When on ice, you should always wear a personal flotation device and safety harness that is tethered to ice anchors or to something solid on shore. Ice thickness over moving water can vary, and the strength of the ice cannot be estimated from the apparent thickness near the shore (see Table 4). You should be aware that ice downstream from bridge supports and other structures may be thin as a result of modified flow patterns and de-icing agents. Honeycombed ice, areas over rapids, and confluences with other rivers and streams should be avoided as ice thickness in these areas will vary. Special care must be exercised during freeze-up and melt (rotting ice) conditions.

### Sources

Environment Canada and B.C. WLAP (2005 c), EMAN-N (2005), Environment Canada (2003 a)

### At a glance

*safety  
assessment*

*use extreme  
caution*

**1** Water quality samplers must have the required ice safety training and recommended equipment prior to collecting water samples through ice.

**2** Ideally, Rescue Canada will perform an ice safety station assessment at all sites to be sampled. This may require that some sites sampled at certain times of the year be attended by at least two people.

**3** For safety reasons, any work on ice and/or in cold weather should be carried out by at least two people.

**4** Wear an approved flotation or survival suit when working on ice over deep or swift water.

**5** Always proceed with caution over ice, and be attached to a tether. Use an ice bar to test the thickness and condition of the ice to make sure that it is safe to work on it. River ice can be thin even in the Arctic if there is a current or warm groundwater inflow (see Table 4). Carry ice safety picks to help in pulling yourself back onto the ice if you fall through.

**6** Carry an extra change of dry clothing with you.

**7** Never drive a vehicle over the ice except where a winter ice road exists and then do so with caution.

**8** If the ice is unsafe, do not take a sample.

### Other sources

Newfoundland and Labrador Environment and Conservation (1999), Environment Canada (1999) draft, Saskatchewan (Undated)

Load	Required Ice Thickness (mm) <sup>1</sup>			
	Continuous Travel		Stationary Load	
	Lake	River	Lake	River
1 person on foot	50	60	75	90
Group, single file	80	90	120	135
Passenger car (2000 kg)	180	210	300	350
Light truck (2500 kg)	200	230	340	390
Medium truck (3500 kg)	260	300	425	500

<sup>1</sup>Effective thickness = Thickness (clear ice) + ½ Thickness (white ice)

Where water lies between layers, use only the depth of the top layer of ice. Under thawing temperatures above average air temperature exceeds zero degrees Celsius, increase the required thickness by 20%.

Source: EMAN-N (2005) from the Alberta Occupational Health and Safety Council 1990.

**Table 4: General guidelines for ice strength (clear blue ice)**

## 2.7 GENERAL PROTOCOLS FOR SAFETY IN FIELD PRESERVATION OF SAMPLES

### Overview

Physical, chemical and biochemical reactions may take place in the sample container between the time of sample collection and laboratory analysis. Storing samples in a cool dark shipping container, such as a cooler, assists in minimizing or slowing down the changes. In some cases, the samples require a preservative before shipping to maintain the integrity of the sample. Strong acids or bases used for the preservation of water samples should be stored and handled with care. Always store preservatives in an upright position before use. Store in a location where the preservatives will not freeze or overheat.

### Sources

Environment Canada and B.C. WLAP (2005 c), EMAN-N (2005), Environment Canada (2006 b)

### At a glance

*Material  
Safety Data  
sheets*

**1** Care must be taken in the handling of preservatives. Experience has shown that minor drops of specific preservatives, such as acids, on clothing or permeable surfaces can create holes. It is possible that mishandling larger quantities of these substances can cause damage to skin and other parts of the body. During use and disposal, preservatives must be handled carefully. Unused or contaminated preservatives must be disposed of using the outlined procedures that the manufacture provided for each different preservative. Samplers should read the MSDS for each preservative to be used. When in doubt, you should contact the supplier.

*gloves and  
safety  
glasses*

**2** Gloves and safety glasses must be worn when preservatives are being used. If you already wear eyeglasses, then safety glasses are not necessary. For certain preservatives, a respirator mask may be necessary.

*dangers of  
sodium  
hydroxide*

**3** An example of the proper handling of preservatives is shown in Photo 4. The sampler wears latex gloves to protect exposed skin areas. Preservatives are stored and dispensed in individual portions. The vials of preservative are handled with great care and disposed of after use into a sealed plastic bag in the field, which is later disposed of according to supplier recommendations.

**4** Avoid the inhalation of preservative vapours or direct contact with the skin, eyes and clothing. Sodium hydroxide used for cyanide preservation is dangerous if it comes into contact with your skin or eyes. Sodium hydroxide has a soapy feel when rubbed between the fingers. If this sensation is noticed, immediately rinse your hands with plenty of water. Like other preservatives, it will cause damage to skin and clothing.

**5** Preservative spills should be tended to immediately by

dilution with a large amount of water followed by mopping up.

**6** If a preservative does come into contact with your skin, the affected area should **immediately** be flushed with large amounts of water. The area may have to be flushed for as long as fifteen minutes.

*seek  
professional  
treatment  
for eye  
injuries  
after first  
aid*

**7** If a preservative gets into your eyes, flush them and the outside of the eyes immediately with plenty of water. It may be necessary to hold the eyelids open during the washing procedure. Continue the rinsing for at least 15 minutes. After first aid, all eye injuries must be professionally treated as soon as possible.

### Other sources

International Standards Organization 2008 (c) Draft, Environment Canada Undated (a), Environment Canada (2008 draft), Saskatchewan (Undated), Environment Canada (2009), Environment Canada (2006 b)



Photo 4. Handling and preserving of samples using safety gloves (Source: Environment Canada and B.C. WLAP (2005))

### 3.0 PROTOCOL FOR CLEANING SAMPLING EQUIPMENT

#### Overview

The effective cleaning of sampling equipment prevents, minimizes and limits the cross-contamination of samples taken during a sampling trip or between sampling trips. This is particularly important when trace parameters such as trace metals, or trace organic constituents are being sampled. Cleaning is also used to remove manufacturing residues from new equipment and to remove dust and any other foreign substances from equipment that has been in long-term storage.

Cleaning of sampling equipment also helps to prevent the transfer of aquatic invasive species from one water body to another. Aquatic invasive species are organisms that have been introduced into a new aquatic ecosystem and produce harmful impacts on native species biodiversity as well as the human use of these ecosystems such as recreational development and fisheries. Aquatic invasive species can be in the form of fish, invertebrates, reptiles, amphibians, algae, and plant species. Many aquatic invasive species can be unknowingly transferred in residual water found in sampling equipment, or on aquatic plants, watercraft, equipment and related sampling gear such as nets and wadders. Simple precautions can prevent the spread of aquatic invasive species from one water body to another.

**Clean** and inspect all equipment, nets, personal gear such as waders, watercraft, and trailer. **Remove** all plants, animals and mud. **Rinse** using high pressure. Extremely hot tap water is preferable - 50°C (120°F).

**Drain** all water from sampling equipment and watercraft including the motor, livewell, bilge at the source or on land.

**Dry** watercraft for at least 5 days in the hot sun (if rinsing is not available). Alternatively, **freeze** all equipment and gear for two or more days, or **soak** all equipment including nets in a 1) table salt water solution (230 g (2/3 cup) of salt to 1 L (1 gallon) water) for 24 hours or 2) undiluted white vinegar for 20 minutes, or 3) diluted household bleach (> 5% sodium hypochlorite at a concentration of 100 ml (~3 ounces) of bleach to 20 L (~5 gallons) of water for at least 60 minutes.

**Dispose** of unwanted live fish at source. Never transport and release plants, animals, mud or water into another water body.

Sampling equipment should be either disposable (single use only) or subjected to rigorous cleaning procedures (depending on the parameters being sampled) and stored in sealed new



plastic bags (e.g., Ziploc) or wrapped in new aluminum foil, depending on what parameters are sampled. Parafilm (self-sealing, moldable and flexible film) can also be used to cover equipment openings to prevent dust accumulation. It may be necessary to replace the sampler and/or rope on occasion if these become excessively dirty or worn.

All sampling bottles should be obtained from the appropriate analytical laboratory, only single use, remain capped before and after actual sampling and used for one specific sampling procedure. The following cleaning procedures are for all non-disposable sampling equipment excluding sample bottles.

### Sources

Alberta Environment (2005 a), Environment Canada and B.C. WLAP (2005 c), Environment Canada (2006 b)

### Special safety concerns

Always add acid to water. Use a fume hood if one is available. If not, wear respirators with the appropriate filters for the hazardous chemicals in use (e.g., acids, solvents). Clean equipment in a well-ventilated area, and wear safety glasses and gloves. Consult the MSDS for all chemicals used in the cleaning procedures for information regarding personnel protection, spill cleanup, and medical treatment directions.

### At a glance

#### General considerations

**1** A 5% (v/v) solution of hydrochloric acid or a 10% (v/v) solution of nitric acid should be used to soak/rinse equipment that is to be used to collect samples for trace metals analyses. Note: if the equipment is to be used to collect samples for nitrogen analyses then nitric acid should not be used.

#### *cleaning solutions*

**2** A non-phosphate, laboratory-grade detergent (e.g. Liquinox, Contrad, Extran) should be used to soap-wash equipment. Use a 0.1-2.0 % v/v solution when cleaning between field trips (higher if required) and use a 0.1-0.2 % v/v solution for field cleaning. To limit soap residue accumulation, do not use >0.2 % v/v solution for field-cleaning

**3** Note: all containers or equipment for trace organic work must be stainless steel, glass or Teflon.

#### *rinsate blanks*

**4** Equipment or rinsate blanks can be collected to test whether there is any residual contamination left on the equipment after cleaning. A rinsate blank is a sample of de-ionized water collected after it has been poured over/through the sampling equipment in question. The water used should be of the highest grade to accurately analyze the rinsate blank samples.

**5** If methanol is used as a solvent then do not use it on equipment destined to collect samples for total particulate carbon (TPC), particulate organic carbon (POC), and total or

dissolved organic carbon (TOC/DOC).

### **Cleaning equipment for trace inorganic analysis**

**1** Perform physical removal with brushes and non-phosphate detergent wash. This removes all visible particulate matter and residual oils and grease.

**2** Tap water rinse and distilled/de-ionized water rinse. This removes detergent residues.

**3** Acid rinse or soak non-metallic sampling equipment. Use either a 5% (v/v) solution of hydrochloric acid or a 10% (v/v) solution of nitric acid. Typically the equipment is subject to either an acid rinse or soak between field trips and an acid rinse when cleaning/decontaminating equipment from the field.

**4** *Acid Rinse*: Equipment should be rinsed thoroughly with acid, ensuring that the acid makes contact with all surfaces likely to be in contact with the sample. Ideally this procedure should be conducted in a fume hood

**5** *Acid Soak*: Ideally equipment should be soaked for 12-24 hours, but USGS (2005) recommends a 30-minute acid soak. Ideally this procedure should be conducted in a fume hood.

**6** Complete multiple distilled/de-ionized water rinses (3-5 rinses). At a minimum the last rinse should be with de-ionized water. To remove all acid residues ensure that the water makes contact with all surfaces likely to be in contact with the sample.

**7** Air-dry in a clean area and on a clean non-metal surface. Avoid areas with dust and fumes.

**8** Store in new, clean Ziploc-type plastic bags, and/or cover equipment openings with new Parafilm. Mark the date of cleaning and the initials of the cleaning personnel on the bag. Transport the freshly cleaned equipment in a clean vessel and store in a clean environment.

*proper disposal* **9** Discard the waste (leftover) acid into a clearly marked waste container and store in hazardous waste area for proper disposal. Consult the MSDS for details and do not store acids close to solvents.

### **Cleaning equipment for trace organic (e.g. hydrocarbon) analysis**

**1** Perform the physical removal of trace materials with brushes and non-phosphate detergent wash. This removes all visible particulate matter and residual oils and grease. Ideally this process should be conducted in a fume hood.

**2** Tap water rinse and distilled/de-ionized water rinse removes detergent residues. Rinse with organic solvents (e.g., acetone, hexane, or methanol). A common procedure is to rinse first with hexane, allow to air dry, rinse again with acetone and then allow the equipment to air-dry again. Equipment should be rinsed

thoroughly with the solvent, ensuring that the solvent makes contact with all surfaces likely to be in contact with the sample. Ideally this process should be conducted in a fume hood.

**3** Complete multiple distilled/de-ionized water rinses (3-5 rinses). At a minimum the last rinse should be with de-ionized water. To remove all solvent residues ensure that the water makes contact with all surfaces likely to be in contact with the sample.

**4** Air-dry in a clean area and on a sanitized surface covered with new (rinsed in hexane/acetone) aluminum foil. Avoid areas with dust and fumes.

**5** Cover the equipment with new, clean aluminum foil and store in new Ziploc-type plastic bags. Mark the date of cleaning and the initials of the cleaning personnel on the bag. Transport the freshly cleaned equipment in a clean vessel and store in a clean environment.

*proper  
disposal*

**6** Discard waste hexane/acetone into a clearly marked container for organic solvents and store in hazardous waste area for proper disposal. Consult the MSDS for details. Do not store acids close to solvents.

#### **Cleaning equipment for specific pieces of equipment: euphotic sampling tube/peristaltic pump tube**

**1** After use, rinse with de-ionized/distilled or tap water inside and out.

**2** Remove foot valve from euphotic tube and soak in 5% HCl.

**3** Fill tubing with 5% HCl and let stand for 6-12 hours.

**4** Thoroughly rinse the inside of the tubing with de-ionized/distilled water (3-5 times) water. At a minimum the last rinse should be de-ionized water.

**5** Re-assemble tubing and store in a clean plastic Ziploc-type bag labeled with date of cleaning and the initials of the cleaning personnel on the bag. Transport the freshly cleaned equipment in a clean vessel and store in a clean environment.

**6** Do not soak the lead weight or the hose clamps in acid.

**7** All tubing should be replaced annually. All weights should be rubber coated and any exposed areas should be repaired.

#### **Cleaning procedures for stainless steel – general water sampling**

**1** Wash with a low residue, non-phosphate detergent (e.g. Contrad, Neutrad or Extran).

**2** Rinse thoroughly with de-ionized/RO water.

**3** Store in new, clean Ziploc -type plastic bags, and/or cover equipment openings with new Parafilm. Mark the date of cleaning and the initials of the cleaning personnel on the bag. Transport the freshly cleaned equipment in a clean vessel and store in a clean environment.

## 4.0 GENERAL PROTOCOLS FOR FIELD NOTES

### Overview

Good sampling practice involves the use of detailed field notes. Specific information about seemingly unimportant facts, such as the time of day or weather conditions, is often significant when interpreting data. A field logbook (3-ring binder with water proof paper) for each project is mandatory. All field measurements should be entered directly into this logbook while in the field. All information recorded in the logbook should be entered into a database immediately upon return from the field.

In addition to documenting standard conditions and measurements, field staff are responsible for noting any unusual occurrences. Any deviations from standard protocols (e.g., samples taken from a different location due to safety or access considerations or procedures used that differ from those outlined here) must be recorded in the database. Upon observing an anomalous condition, such as an unusual colour or odour, excessive algal growth, indications that foreign substances have entered the system (oil slicks, surface films, etc.), or fish kills, the field investigator should take samples in addition to those required by the project design.

Field notes that are taken during sampling are often critical in the interpretation of the data, in some cases even several months or years after the sampling event has taken place. Another advantage of keeping good field notes is that notes can be reviewed prior to completing additional sampling. This can be helpful if sample collection points change throughout the year. By noting historical records, it is possible to collect more representative samples, thereby ensuring the integrity of the sample. Historical records provide insight into the preparation of a sampling trip and the possible hazards or conditions that a site may contain.

### Sources

British Columbia MWLAP (2003), Environment Canada and B.C. WLAP (2005 c), Alberta Environment (2006 a), EMAN (2005)

### At a glance

*information  
to be  
recorded*

**1** Record standard information for the site, including site name and number, date and time of day, sample collector's names, GPS or other coordinates, etc.

**2** It is critical that the following parameters be recorded at each site as soon as the measurement has been taken:

- field measurements of air and water temperatures,
- pH,
- water clarity,

- dissolved oxygen and specific conductivity (or other).

Field instruments are available to measure the parameters (listed above) individually and as multi-meters. Specific field instruments coincide with devices that can record and log data in situ.

*preserving  
information  
and notes*

**3** Unusual conditions that may interfere with the collection of a representative sample should be documented.

**4** Preferably, this information will be recorded on water-proof paper, handheld device or laptop and filed in a specific area for each site.

**5** Samplers must avoid taking all field notes for a site with them during each sampling event; since this potentially can lead to the loss of a significant amount of information should an accident occur.

**6** Laboratory submission sheets need to be completed by the sampler identifying the date and location of the sample and any field measurements.

**Other  
sources**

ISO 2008 (b), Alberta Environment (2006 a), Environment Canada Undated (a)

## 4.1 GENERAL PROTOCOLS FOR CHAIN OF CUSTODY

### Overview

Samples need to be collected using specific techniques and appropriately labeled for accurate identification by the laboratory. It is important to ensure appropriate documentation accompanies the sample, and samples reach the laboratory in a timely manner. Samples that are time sensitive must arrive within enough time to ensure analyses can commence immediately upon arrival without affecting the integrity of the sample. This may require the samples be collected early in the week to coincide with travel time or ensure that arrangements are made with the laboratory to accept the samples and start analyses immediately.

A chain of custody/sample submission form is applicable for all projects but the form is crucial if the project is being carried out for legal reasons (e.g., compliance monitoring). This form is critical to the validity or soundness of the project and guarantees that the sample has not been tampered with. It also ensures that only authorized personnel handle samples and that proper field sampling techniques for the program are used. All transfers of samples are noted on the form. Transfer procedures are also described to make sure samples are properly protected and preserved. Any changes in sampling or sample storage should be noted on the chain of custody form. The information recorded on the form should be kept on file for the project.

### Sources

Ontario Ministry of the Environment (2006), EMAN-N (2005)

### At a glance

#### *timing issues*

**1** Preferably, samples are collected early in the week or on a weekend so that the samples can arrive at the laboratory when it is open and samples do not have to sit unattended. This is especially important when time-sensitive (e.g., bacteriological samples) or legal analyses are being requested.

#### *proper labeling*

**2** Bottle and other sample container labels should be marked with permanent waterproof markers, water-proof pencils or with peel and stick labels. Every bottle must be labeled with the field sample number, sample name, site number, date of sample, time, analyses requested for sample (e.g., Metals) and preservatives/filtration used.

**3** Information should be recorded on the sample submission form using a pen or a water-proof pencil, since felt markers or common lead pencils can smudge and rub off. Write as neatly and legibly as possible.

**4** Keep submission forms dry by storing in a Ziploc-type plastic bag and either placing on the top of the cooler/container with the samples and ice/ice packs or in a pouch located on the inside of the top of the lid.

*information  
needed on  
forms*

**5** Forms should contain the following information (important for the laboratory receiving the samples): client and program information; station location description; sample matrix and type; laboratory analyses (according to appropriate detection limits) requested; field sample identification number; submission date and time of collection (preferably 24-hour clock); sampler name and contact phone number; water and air temperature on sampling; and comments on any unusual conditions.

*legal  
sampling*

**6** For legal sample collection, individual samples need to be sealed and initialed prior to packing in the storage cooler. After preservation has been finished, the storage cooler itself should be sealed and initialed. The cooler must remain in the custody of the sampler with appropriate legal forms until it is turned over to the next person in the submission chain and signed-off by the sampler. Actual procedures for legal sampling should be followed by samplers who have completed a recognized legal sampling procedure course.

**7** Rapid transportation of the samples to the laboratory is recommended, especially in the case of legal samples.

## 4.2 PROTOCOL FOR STORAGE AND SHIPMENT OF SAMPLES

### Overview

Field samples should be stored at 4°C in a mobile laboratory refrigerator, portable refrigerator, or a cooler containing ice packs in the summer months. In below freezing temperatures, place the samples in a cooler containing collapsible warm water jugs. Store the sample as necessary, until they can be transferred to a temporary holding refrigerator or refrigeration facility. This will make sure that they are preserved properly and that there is no loss of sample quality. If refrigeration is not available, field activities and transportation of samples must be planned so that samples are sent immediately to the laboratory.

### Sources

EMAN-N (2005), Environment Canada (1999 Draft)

### At a glance

- ship samples asap*
- 1** Samples should be shipped as soon as possible after collection. Ship samples in coolers containing enough ice packs or collapsible water jugs with warm water, to keep the samples at approximately 4°C for the length of the trip. Whenever possible, send samples to the laboratory the same day they were collected.
  - 2** Each shipping container should contain only bottles that are to be analyzed or cleaned by the receiving laboratory. All samples must be well sealed and packed using foam chips or bubble wrap to prevent spillage or breakage. The laboratory will re-wash all empty bottles. Any dirty bottles that are returned should have their lids on. Rinse old reagent bottles well before returning them.
  - protect forms to be included with samples*  
**3** Be sure to include a copy of the sample field sheet and/or submission form with each shipment. A chain of custody form for the samples, if required, must also be contained in each shipping container. These forms should be placed inside a sealed plastic bag in the shipping container to protect them in case of leakage or breakage of samples.
  - proper labeling of shipping containers*  
**4** Label all shipping containers with the address of the destination and the sender. The address labels should be taped over with clear tape to protect against scuffing or marking. Label the top of all shipping containers with “OVER 16 KG”, “THIS END UP” or “FRAGILE”, as applicable. “DO NOT FREEZE” labels are also useful. Make sure containers are free of misleading address and warning labels. Multiple containers should be numbered in a series out of a total number (for example “3 of 6”).
  - 5** If a cooler is being used to ship the samples, make sure the spigot is taped over to prevent leakage. At least one piece of tape should be used over the closure clasp. Coolers should also have secure handles. Any broken handles or sharp projections should be removed.



- be aware  
and follow  
all  
Transport of  
Dangerous  
Goods  
regulations*
- 6** Proper documentation or handling receipts from the transportation/shipping company should be kept on file so that lost or damaged shipments can be traced.
- 7** It is very important to follow all *Transport of Dangerous Goods* regulations for packaging, labeling, and documenting sample boxes. Normally, preserved samples are not considered to be dangerous goods because of the much diluted amount of preservative. However, the shipper is responsible for the goods. Consider becoming a certified shipper of dangerous goods in order to protect yourself and personnel who may be transporting the samples as well as those receiving them. If you have doubts about any aspect of the regulations, contact your area Transport of Dangerous Goods Trainer or Transport Canada.

**Other  
sources**

BC WLAP (2003), ISO (2008 a) , Environment Canada Undated (a), Environment Canada (2008 draft), Ontario Ministry of the Environment (2006), Newfoundland and Labrador Environment and Conservation (1999), NB 2000, Saskatchewan (Undated), Environment Canada (2009), Nova Scotia Department of Environment and Labour 1996, Environment Canada (2003 a)

## 5.0 GENERAL PROTOCOL FOR FIELD FILTRATION

### Overview

To find the concentration of dissolved constituents, water samples must be filtered through a 0.45 µm cellulose acetate membrane filter. This can be done in some cases by the laboratory but often involves filtering samples in the field (or field laboratory). All parts of the filtration system must be washed including the tubing, filter flasks and funnels unless you are using disposable filter units. These disposable units will reduce sample contamination. Otherwise all filtration equipment must be washed before leaving for the field and between filtration of each sample. The filtration equipment must be washed between replicate samples as well.

### Sources

Alberta Environment (2006 a), EMAN-N (2005), BC WLAP (2003)

### At a glance

**1** Filter units and related apparatus (see Figure 1) must be kept clean, using routine procedures such as acid washes and soakings in de-ionized water. Cleaned filter units should be stored in labeled, sealed plastic bags to prevent contamination.

**2 General filtration:** Immediately before field trips, clean the inside of all tubing by filling it with 5% HCl and allowing it to soak for six hours or more. Then pump approximately 500 mL of de-ionized water through the tubing. Wash filter flasks and funnels with a non-phosphate laboratory detergent (e.g., Liqui-Nox). Rinse these three times with tap water, followed by de-ionized water four times. Then soak the filter flasks and funnels in a 5% HCl bath overnight. After soaking, rinse four times with tap water followed by de-ionized water four times.

**3** Before each filtration, pump approximately 250 mL of de-ionized water through all tubing. Rinse filter flasks and funnels with de-ionized water three times.

*wash  
filtration  
equipment  
between  
replicates*

**4** After filtering highly turbid samples, pump about 500 mL of 5% HCl through the tubing, followed by about 200 mL of de-ionized water. Scrub and wash the filter flasks and funnels with 5% HCl. Rinse often and well with de-ionized water. If no sediment appears to be sticking to the filter unit, this HCl wash may be left out. The filtration equipment must be washed as outlined between sample replicates as well.

### Other sources

ISO (2008 a), Environment Canada Undated (a), Environment Canada (2008 draft), Environment Canada (2006 b), Environment Canada (1999), Environment Canada (2009)

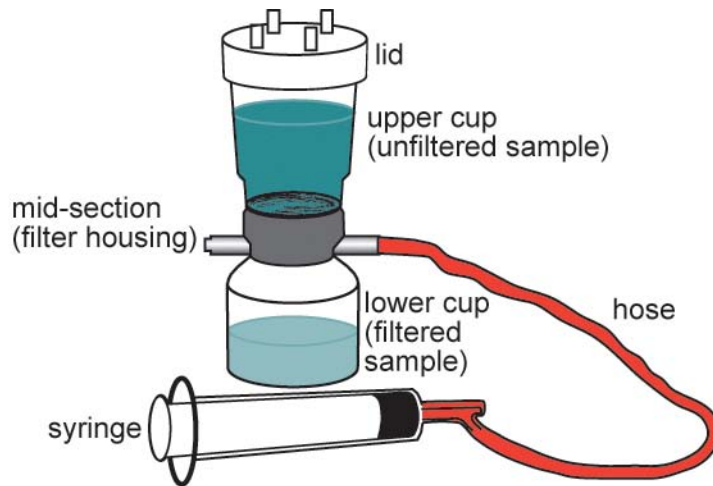

Figure 1. Example of filtration apparatus (Source: BC WLAP (2003))

## 5.1 PROTOCOL FOR FILTERING PHOSPHORUS AND NUTRIENT SAMPLES

### Sources

Environment Canada (2006 b), Environment Canada Undated Wolfe Island Field Site Sampling Protocol (Draft)

### At a glance

- 1** Rinse glassware with Milli-Q water. Use fully open glass filtration cup. Wearing disposable gloves and using tweezers, place cellulose filter on filtration holder. Place filtration cup on holder and clamp securely.
- 2** Clean glassware, using glass 500 mL graduated cylinder, filter aliquot (250 mL) of raw sample water. Rinse this filtrate around the Erlenmeyer flask and pour out. Repeat using the same filter paper.
- 3** Change filter paper and filter another aliquot (750 mL) of raw sample water. Using the filtrate, rinse the sample and duplicate bottles, and lids, twice, then fill bottles with sample water.
- 4** Using the filtrate, rinse the 125 mL glass sample bottles and lids twice, then fill with sample water. Add 1 mL of 30% sulphuric acid preservative to each phosphorus bottle and mix well by inverting. Store the samples in a refrigerator
- 5** Remove filter paper from the filtration unit, and rinse the filtration unit with 200 mL Millipore water. Pour water out in a sink; allow water to drain from Erlenmeyer flask.
- 6** For **chlorophyll-a** samples, ensure that the sample bucket and filtering apparatus are kept out of direct sunlight. Rinse the filter funnel and graduated cylinder between samples with de-ionized water. Always use forceps marked for chlorophyll-a filtering when handling filters.
- 7** For **particulate nitrogen and carbon**, rinse filtration glassware with Milli-Q water methanol then sample water. Wearing gloves and using tweezers, (do not touch with fingers), place a Whatman GF/C filter on the filtration holder. Place the square slotted filtration cup on the filter and clamp securely.
- 8** Using the glass 500 mL graduated cylinder, filter an aliquot (total 1000 mL), of well mixed whole water. The vacuum is set at 5-7 psi, the depth of sample water in the cup 2-4 cm. Ensure there is no leakage at the edge of the filter paper. The final sample should be contained only in the small rectangular opening of the filtration cup.
- 9** After the water sample has passed through the filter, rinse the inside of the filtration cup with 2-5 mL of Milli-Q water. Maintain the vacuum at 5-7 psi. Carefully add 2-5 mL of 0.1 N H<sub>2</sub>SO<sub>4</sub> to the filter and continue to filter, (sulphuric acid removes carbonates). Rinse again with 2-5 mL of Milli-Q water.
- 10** With vacuum on, remove filtration cup. Continue vacuum

*keep out of direct sunlight*

*always wear gloves*

filtering to remove any excess water from the GF/C filter. When filter paper is drained, turn off vacuum and transfer filter paper carefully to a labeled Petri dish (label with date, site, volume, parameter and duplicate code if required). Wrap Petri dish in foil and place in a vacuum dessicator (20 psi) for 2-3 days. When the filter paper is dry, place the Petri dish in an air-tight container in a refrigerator.

## 5.2 PROTOCOL FOR CONVENTIONAL FIELD MEASUREMENTS

### Overview

*In situ* measurements of parameters such as pH, dissolved oxygen, temperature, conductivity, turbidity, and redox potential are routinely taken at the time of sampling. These measurements are taken *in situ* in the water body just below the surface, at mid-depth or at discrete depths depending on the sampling objective and the depth of the sampling site, using electronic single or multi-probe meters.

The proper maintenance and calibration of instruments is a very important part of any water quality program. The instruments must be in good working condition in order to get accurate results. Field personnel must understand the calibration and use of any instrument they are using in the field. Maintenance and calibration log books should be kept up to date to track the performance of the meter. The meter probes should be calibrated daily under field conditions and temperatures, and periodically throughout the day if required (e.g., dissolved oxygen at sites of different altitudes or every five samples if water quality changes dramatically from site to site). The exceptions are: temperature (check in laboratory monthly with a certified mercury thermometer), conductivity and turbidity (calibrate at the beginning of the sampling trip), and redox potential (calibrate once every six months).

Review the water quality data on-site during sample collection to prevent the measurement and/or recording of false measurements. Re-measure and double check any dubious readings before leaving the site. It may also be worthwhile doing verifications at the end of the day for some key parameters (not re-calibrations) to check if the meter has drifted or is malfunctioning. Meter readings should be checked in standard solutions and recorded in the log/field book. This ensures that the meter has been working properly throughout the day.

### Sources

Environment Canada and B.C. WLAP (2005 c), Alberta Environment (2006 a), EMAN-N (2005)

### At a glance

**1** If taking field temperature measurements with a thermometer, remove the cover and place it in the shade, out of the wind, preferably about 1 metre above the ground to minimize the heat influence from anything other than ambient air temperature. Leave the thermometer for five to ten minutes or for the time it takes to collect the water samples. Record the air temperature to the nearest 0.5 degrees Celsius. Temperature measurements of the water must be taken in the field

immediately upon obtaining a sample or preferably *in-situ*, by means of automated temperature probes.

*calibration*

**2** Calibrate the multi-probe/meter prior to daily sampling for pH and DO. Conductivity and turbidity can be calibrated at the beginning of the sampling trip and redox potential should be calibrated every six months. Temperature should be calibrated every month with a certified thermometer.

**3** *In situ* measurements at sites <2m deep should be taken just below the surface of the water (0.1 m depth).

**4** *In situ* measurements at sites >4m deep, should be taken just below the surface of the water (0.1 m depth) and at 1 m intervals down to 1 m above the lake bottom. At sites  $\leq 2$  m deep, one set of measurements at mid-depth might be considered appropriate. At sites between 2 and 4 m deep, two measurements can be taken 0.25 m below the surface and 0.25 m above the lake bottom. It is preferred to take field water quality readings from the body of water itself (*in situ*) but on some occasions it may be necessary to take the measurements from a sub-sample of water. In this case take separate water samples for these field measurements and never take field water quality measurements from samples to be submitted to the laboratory for analysis.

*let the instrument stabilize at each depth*

**5** Let the instrument stabilize at each depth (usually 1-2 minutes) and record the readings in a field sheet/book. Also, if possible store readings at each depth in a datalogger. On deep profiles and where approved by the project manager, it may be acceptable to proceed at 5 m intervals if there is little change in readings at 1 m intervals. When change is detected (thermocline, chemocline, etc.), then define the area of change at 1 m intervals.

**6** Bring the probe/sonde back up to 1 m, allow to stabilize and record readings at that depth. (Note: redox will probably not stabilize quickly at the surface.) This acts as a field check on the instrument and verifies the accuracy of the first reading.

**7** New **conductivity** meters may use different types of probes. Follow the manufacturer's instructions for use. Conductivity meters are also available for "pure water" (i.e., conductivity from 0 – 100  $\mu\text{S}/\text{cm}$ ) and for high conductivity waters (100 – 1000  $\mu\text{S}/\text{cm}$ ). The sampling circumstances may need both ranges.

**8** **pH** should be measured after the conductivity measurement using a pH meter. Adjust the temperature reading (if needed) to the temperature of the field sample. Shake the sample and rinse the electrode with sample. Place the electrode in the sample. Select pH measurement mode. Swirl the sample and measure the pH. Allow sufficient time for the meter to stabilize. Be sure to rinse the electrode with de-ionized water before storage. Store the electrode in a potassium chloride (KCl) storage (long-term) solution according to the manufacturer's instructions. pH electrode sensors should be kept wet with sample water or tap

water, and not in a standard solution, at all times during sampling.

**9 Dissolved oxygen** can be measured using multi-meter DO sensors that have appropriate membranes and are properly calibrated. The meters measure the level of dissolved oxygen in both milligrams per litre and percent of oxygen saturation. Follow the manufacturer's instructions for measuring DO, calibrating the meter and keeping the probe clean. One water sample taken at one profile depth per water body can be subjected to a Winkler analysis as a further check of the accuracy of the DO meter measurement, preferably at a depth where oxygen appears stable. A meter DO measurement within  $\pm 0.5$  mg/L of the Winkler DO measurement is generally considered acceptable, however USGS (2005) recommended that meter and Winkler DO measurements should be within  $\pm 0.05$  mg/L DO.

**10 Turbidity** is measured as follows. Fill a *cuvette* with shaken field sample to the line marked on the cuvette. Dry the cuvette with a clean, lint-free, laboratory-grade paper towel. Place the cuvette with the orientation mark facing forward in the chamber. Note: Handle the cuvette with care and do not touch the area of the cuvette below the line. Keep the cuvettes absolutely clean. Measure the turbidity of the sample. Rinse the cuvette with de-ionized water before storage.

#### Other sources

ISO (2008 a) , B.C. WLAP2003, ISO 2003 (a), Ministère de l'Environnement, Gouvernement du Québec (2000), Environment Canada Undated (a), Environment Canada (2008 draft), Ontario Ministry of the Environment (2006), Newfoundland and Labrador Environment and Conservation (1999), Prince Edward Island Undated, Environment Canada (1999) draft, New Brunswick 2000, Saskatchewan (Undated), Environment Canada (2009), Nova Scotia Environment and Labour 1996, Environment Canada (2003 a), Environment Canada 2003 (f), Environment Canada 1998, Environment Canada 2003(e)



## 6.0 PROTOCOL FOR GENERAL SAMPLING METHODS

### Overview

Water samples can be taken by wading into the water, from a boat during open water seasons, or through the ice. Samples can also be taken from docks, bridges and the floats of an airplane. Some water samples can be analyzed in the field at the time they are collected, while other samples are collected for later analysis in a laboratory. When possible take samples from the same location, regardless of whether it is open water or ice covered. The use of a global positioning system (GPS) to identify geographic co-ordinates will ensure that the sampling site is precisely located. If applicable, document the change from the original sampling location, and the particular reason for the location change.

Samples near the surface can be taken by holding the collection bottle and lowering it into the water until covered. This hand-held method of sampling, commonly called ‘grab sampling’, is the simplest way of collecting a water sample. The sample bottle should be held as show in Figure 2.

It is beneficial to be prepared before heading out to sample with all necessary equipment; this may include meters for field measurements and field log books, QA/QC sample bottles, and field bottles. Samples can be collected in the most efficient and safe manner if a methodical approach is taken. This may involve tethering the sampler to a second individual or ensuring applicable testing is completed before entering an enclosed space to collect samples. Ensure that safety comes first before beginning the sampling process.

### Sources

Environment Canada and B.C. WLAP (2005 c), Alberta Environment (2006 a), EMAN-N (2005)

### At a glance

**1** When sampling streams, unless otherwise specified, aim for the mid-stream. When specified samples may need to be collected near one or both shores. The sample location will be determined in the study design component. A reconnaissance of the site will determine the coordinates (via GPS unit), or specific landmarks that identify the sample site.

*order of  
grab  
samples*

**2** When collecting grab samples, there is a particular order that should be followed during collection. First grabs samples taken should be any blanks that are needed at the site. These are followed by “clean” samples such as those used to measure bacteriology (including any such replicates). Then samples from which field measurements are measured (if these are not being calculated in the source water itself). Finally, any remaining samples, which would include any related replicates.

*carry samples in cooler with ice packs*

**3** Ideally, sample bottles should be carried to and from the sampling vehicle in a cooler that has ice packs. Sample bottles should be packed in the cooler and field notes added to the laboratory requisition sheet. Once sampling has been completed on site, meters should be returned to their carrying cases, additional sampling and safety gear collected and stored in the vehicle for transit to the next site.

**4** A sampler's responsibility is to:

- collect samples as directed in the study design,
- note unusual conditions at a site where he/she repeatedly sample,
- minimize field error to the greatest amount possible, and
- ensure that the best possible sample is collected to produce the most representative results.

**5** Tightly cap all the bottles and place them upright in the shipping container for transport. Return the bottle for trace metals to the Ziploc-type bag. Be sure that any glass bottles are not in contact with each other by placing plastic bottles between them.

*samples must arrive at the laboratory as close as possible to the 4°C ideal temperature*

**6** Place the ice pack(s) in the sampling kit immediately. Bottles that are most temperature-sensitive should be arranged at the bottom of the shipping container as close as possible to the ice pack(s). During the warmer summer months, shipping coolers must be kept out of the sun and away from any other heat sources. Loose or bagged ice should never be used in the shipping containers because of the possibility of contamination. As a general guideline, the volume of sealed ice should be equivalent to the volume of sample water included in each cooler sent to the laboratory. Ice packs must be included in every kit because of short-term storage of the shipped coolers in heated buildings, courier trucks, etc. If necessary, use additional ice packs during the summer months. . In the winter months with below freezing temperatures, collapsible jugs of warm water should be packed in the cooler to prevent freezing of the samples. Extra caution should be taken packing individual samples in bubble wrap in extreme cold conditions since glassware and plastic sampling bottles may shatter in transit. Samples must arrive at the laboratory as close as possible to the ideal temperature of 4°C, and within the 48-hour time limit.

## **Other sources**

BC WLAP (2003), ISO 2003 (a), ISO (2008 a), Environment Canada (2008 draft), Ontario Ministry of the Environment (2006), Newfoundland and Labrador Environment and Conservation (1999), NB 2000, Saskatchewan (Undated), Environment Canada (2009), Nova Scotia Department of Environment and Labour 1996

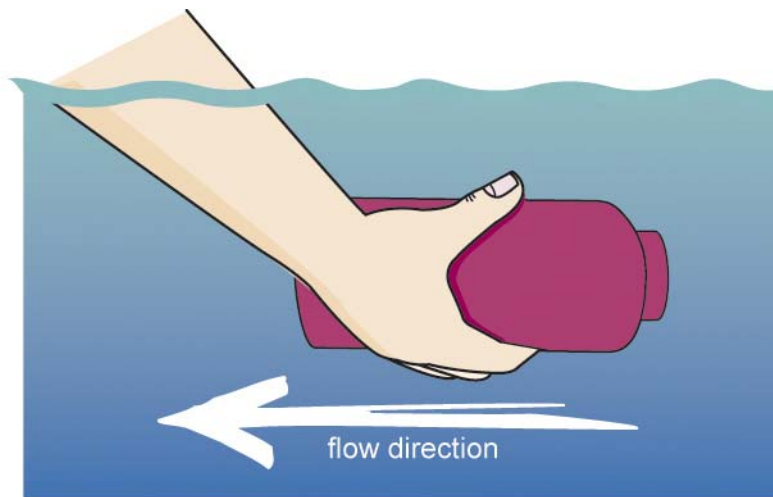

Figure 2. Technique for taking hand-held grab samples (Source: EMAN-N (2005))

## 6.1 GENERAL PROTOCOLS FOR TAKING SECCHI DISC MEASUREMENTS

### Overview

Secchi discs (Photo 5 and Figure 3) are used to provide a visual measure of water clarity or optical depth. The Secchi disc is lowered into the waterbody and the depth is at which the pattern is no longer visible is taken as the measure of clarity. Measurements should be made every two weeks if possible between June and October.

Secchi depth measurements should be in a shady location and the observer should not wear sunglasses. Ensure to record the time of sampling, since this may influence the Secchi measurement. The optimal time for taking a Secchi measurement is mid-day. Take at least two measurements at each sampling site/station and estimate the optical depth based on the mean of these two measurements. Ideally the Secchi disc measurement should be accurate to within  $\pm 1$  cm. The higher the Secchi disc reading, the clearer the lake. If the light meter is not operational, determine the approximate euphotic zone (depth of 1% incident radiation [light]) by multiplying the Secchi disc reading by 2.



Photo 5. Secchi disc (Source: CRE Laurentides)

### Sources

Développement durable, Environnement et Parcs, Gouvernement du Québec (2007 a), EMAN-N (2005), Alberta Environment (2006 a)

### At a glance

- 1** Take the Secchi reading on the shaded side of the boat using a calibrated cord or chain. (Use a permanent marker to mark intervals as tape wrapped around the rope tends to loosen and slide over time.)
- 2** Slowly lower the disc into the water until it disappears from

sight and note the depth (Depth 1).

**3** Lower the disc down a further 1 m (or until it is well out of sight) then slowly raise the disc until it is visible again and note this depth (Depth 2).

**4** The Secchi disc reading is the average of the two recorded depths (Depths 1 and 2). Record the time of sampling. The higher the Secchi disc reading, the clearer the lake. The depth at which the Secchi disc disappears or appears may vary from observer to observer and from day to day due to light conditions.

*average of  
two  
readings*

**Other  
sources**

Environment Canada (2009), Nova Scotia Department of Environment and Labour 1996

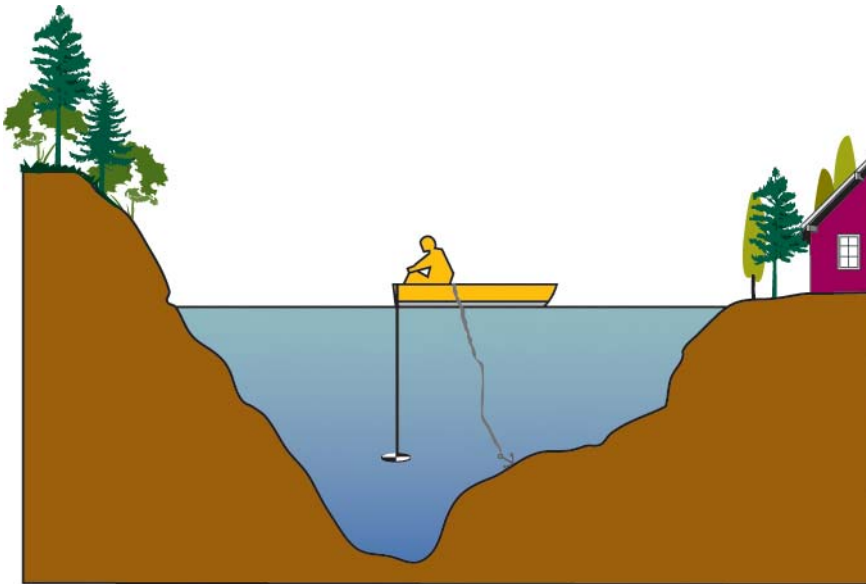

Figure 3. Secchi disc measurements (Source: CRE Laurentides)

## 6.2 WATER COLUMN SAMPLING TECHNIQUE PROTOCOLS

The Protocols that follow are in relation to sampling specific variables in the water column.

### 6.2.1 PROTOCOLS FOR SAMPLING THE WATER COLUMN FROM BOATS & AIRCRAFT

#### Overview

Quality assurance and control measures (see appropriate Protocol) and safety issues (see appropriate Protocol) should be adhered to. The Protocol identifies how samplers should be fastened, where the sample should be collected from, and how to minimize the potential for sample contamination.

#### Sources

EMAN-N (2005), Environment Canada and B.C. WLAP (2005 c), Environment Canada (2001)

#### At a glance

*sample from the upstream side*

**1** In moving water, always sample from the upstream side to prevent contamination of the sample from gas or oil. This will make sure that neither your body nor your actions can affect the water being sampled (e.g., by disturbing the bottom material of sediment and biota). Grab samples can be collected while the boat is anchored or drifting along mid-channel.

**2** When using a weighted sampler in rivers or lakes, you can either anchor or keep the boat running depending on the circumstances. For example, if there is a danger of ice floes, do not anchor the boat. Keep the engine running to make sure that the boat can be moved out of danger.

*grab sample*

**3** For samples at water depths less than 50 cm, the sample may be collected by hand (grab sample). Dip and fill the bottles directly from the water. Hold the bottle near its base and remove the cap (lid) without touching the inside of the cap. Plunge the bottle, neck downward, below the surface to a depth of about 20 cm. Immediately turn the bottle until the neck points slightly upwards with the mouth directed into the current (see Figure 2). Hold the bottle facing upstream at arm's length while it fills. If conditions permit, before filling the bottle with the sample water, rinse all bottles as directed by the laboratory.

**4** Unless specified by the laboratory, fill the bottles to approximately 0.5cm from the top with the sample water. This allows the water to expand and/or also allows for the addition of preservatives. Preserve and complete field analyses as necessary. Cap each bottle immediately after filling, tape the lids closed on all the sample bottles so that they do not accidentally come off and carefully place in a chilled cooler or backpack.

**5** For samples collected at depth, follow instructions in the section titled *Protocol for sampling the water column in lakes and streams at depth*.

## 6.2.2 PROTOCOL FOR SAMPLING THE WATER COLUMN FROM BRIDGES

### Overview

The Protocol identifies how samplers should be fastened, where the sample should be collected from, and how to minimize the potential for sample contamination when collecting a sample from a road or bridge structure (Figure 4).

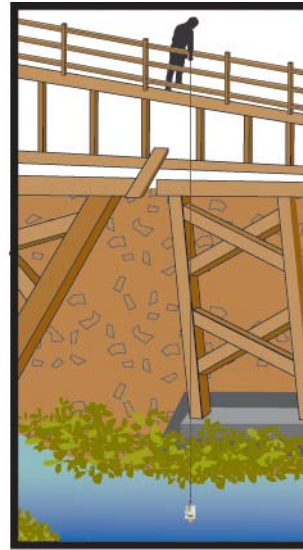

Figure 4. Sampling from a bridge  
(Ministère de l'Environnement,  
Gouvernement du Québec (2000))

### Sources

Environment Canada and B.C. WLAP (2005 c), Ministère de l'Environnement, Gouvernement du Québec (2000), Environment Canada (1999 Draft)

### Special safety concerns

*be aware of boaters and water skiers*

*use bridge walkway*

**1** Special care must be taken when sampling from bridges over navigable water as boat operators and water skiers may not be able to see the sampler ropes. It may be necessary to flag equipment so that it is easily visible. Should a boat approach the bridge at the time of sampling, raise the multiple-sampler and temporarily suspend your sampling until it passes.

**2** Power lines strung along or close to bridges should also be respected and avoided. At no time should the rope attached to the multi-sampler be draped over a power or telephone line.

**3** The bridge walkway must always be used regardless of which side it is on. However, in very fast currents it may be necessary to sample on the downstream side on occasion to prevent the multi-sampler from being swept too far under the bridge.

### At a glance

**1** Sampling should be undertaken on the upstream side of the bridge structure unless safety or other issues make this

*Sample on the upstream side of the bridge* impractical. Samples should usually be collected at about mid-stream. The precise location at which the sampling device is lowered from the bridge should be marked to ensure that the same section of the river is sampled each time. Before sampling, check for floating debris.

**2** Secure the free end of the rope attached to the sampler to the bridge rail to prevent accidental loss of the equipment. Keep equipment out of the traffic lane where it may be struck by a vehicle. Ensure that the sampling spot chosen is not near any drainage pipes/holes that may be present.

**3** Begin to release the sampler and rope, making sure that it does not come into contact with the bridge as this will cause dirt or other contaminants to fall into the sample bottles. The goal of this technique is to ensure that the amount of contamination that might arise is minimized. As it gets near the water, begin a swinging motion of the rope so that the sampler can enter the water body upstream from the bridge.

*minimize number of casts*

**4** When using a multi-sampler, it is important to allow sample bottles to fill with the fewest number of casts. To do this, the sampler should be swung as far upstream as possible before releasing it and try to fill the sample containers by the time the current has carried it downstream. This also allows the sample to be collected upstream from the bridge, which is potentially closer to where on-ice samples (where used) should be collected.

**5** Do not allow the sampler to come in contact with the stream bed as this will stir up sediments and contaminate the sample.

## Other sources

ISO (2008 a), Ontario Ministry of the Environment (2006), Newfoundland and Labrador Environment and Conservation (1999), BC WLAP (2003)



## 6.2.3 PROTOCOL FOR SAMPLING THE WATER COLUMN THROUGH ICE

### Overview

Quality assurance and control measures (see appropriate Protocol) and safety issues (see appropriate Protocol) should be adhered to. The Protocol identifies how samplers should sample, where the sample should be collected, and how to minimize the potential for contamination when collecting a sample. Sampling locations to be sampled in the winter should be located as close as possible to the open-water.

### Sources

Environment Canada and B.C. WLAP (2005 c), EMAN-N (2005), Alberta Environment (2006 a)

### Special safety concerns

It is important when sampling on ice that all safety precautions are followed. Identify before venturing on ice the climatic conditions of the previous weeks (i.e. warmer temperatures, rainfall). Ice thickness should be correctly determined with a probe bar. Special care must be taken at outflow and inflow areas; the movement of the water does not allow ice to form thickly.

### At a glance

**1** It is important to try and keep the sample location the same throughout the seasons. If during the summer the sampling is to be completed near a bridge, the site should be selected far enough upstream from the bridge to avoid contamination from road salt and sand during the winter season.

*keep area  
around drill  
hole clean*

**2** Clear loose ice and snow away from the sampling location and drill through the ice with an ice auger, either motorized or a hand auger. The area around the drill hole should be kept clean and free from potential contamination such as gas, dirt from the drill or boots, from snowmobile exhaust, etc. All the ice chips and slush should be removed from the drill hole using a plastic sieve. Allow several minutes for the water to flow freely under the ice, thus allowing potential contaminants to clear, before taking a sample.

**3** In shallow streams, samples should be collected approximately 0.2 m below the bottom of the ice using a grab sample if possible. In deeper waters, samples need to be collected with a weighted sampler.

**4** Lower a clean, opened 2L bottle in a weighted sampler (with 2 to 3 kilograms of extra weight added) to the desired depth. If sampling in a current, the weight should be enough to reduce the sampler's downstream drift. Lower the bottle into the river at a rate that will give a depth- integrated sample.

*avoid  
stream  
bottom*

**5** Do not let the sampler come in contact with the streambed. This may stir up bottom sediments and contaminate the water sample. Raise the filled bottle from the river and use the water to rinse it, if conditions permit. Repeat steps 1 through 4 until the bottle is re-filled.

**6** In extreme cold temperatures well below freezing, do not

*rinsing in  
extreme  
cold*

rinse bottles with sample water, the sample water will freeze to the surface of the bottle. Alternately, rinse the sample bottles with laboratory-certified water in the vehicle prior to sampling following normal rinse procedures.

**7** Record ice depth and total depth. All sample bottles should be clearly labeled with date, time, location, site, depth, analysis required and sampler identification. Store and transport all samples at 4°C in a closed cooler. Collapsible jugs of warm water can be used in the cooler between the samples to prevent the samples from freezing. Do not allow the samples to freeze.

### Collecting field blanks

**1** Winter field blanks for stations that are sampled through ice consist of bottles filled with de-ionized water. These field blanks are processed as follows: remove the cap from the acid-washed field blank bottle containing de-ionized water, and expose the de-ionized water in the bottle to the air for approximately the same amount of time it takes to collect a regular water sample. Using this bottle, fill the metals bottle from field blank sampling kit with the de-ionized water.

**2** Remove cap from the regularly washed 2-litre field blank bottle (size may vary with laboratory) containing de-ionized water and expose de-ionized water to air. Fill all remaining bottles from the field blank sampling kit using the de-ionized water from this bottle.

**3** Complete the field form. Measurements of air temperature should be included; measurements of water temperature are not required.

### Collecting replicate samples

**1** After the field blank has been processed, fill a 2L bottle (size may vary with laboratory) marked as a regular sample and fill the metals bottles from the replicate kit and the regular sampling kit at the same time. Next fill a second 2L bottle (size may vary with laboratory) and fill each of the bottles from the replicate and regular sample kits simultaneously. For example, fill a 1L plastic bottle (size may vary with laboratory) from the replicate and regular sample kit together. Repeat until all the bottles from the replicate and regular sample kits are filled.

**2** Once the replicate sample has been collected, complete the field form as normal. Ensure that preservation and field analysis of the samples is carried out. Tape the lids closed on all the sample bottles so that they do not accidentally come off. Carefully re-pack the bottles so that they do not break during transport.

### Other sources

ISO (2008 a), BC WLAP (2003), Environment Canada (1999), Newfoundland and Labrador Environment and Conservation (1999), Saskatchewan (Undated)

## 6.2.4 PROTOCOL FOR SAMPLING THE WATER COLUMN IN LAKES AND STREAMS AT DEPTH

### Overview

Normally samples are taken from the deepest area of the water body. This type of sampling allows the characterization of water quality at various depths and so provides information as to how water quality changes with depth due to factors such as stratification, sediment release, mass balance, etc.

### Sources

Alberta Environment (2006 a), British Columbia MWLAP (2003)

### Special safety concerns

When sampling from a small watercraft, it is important to be organized. Space is at a minimum and confusion with ropes from anchors, sampling equipment and additional instruments can cause a tripping hazard. Ensure all water safety gear is worn. Delegate responsibilities, for example, one individual is responsible for taking field measurements or raising and lowering the anchor, while the second individual collects the water samples.

### At a glance

*collect samples at bow*

**1** The boat should always be anchored when doing a profile. Samples should always be collected at the bow of the boat. The bow will always point into the wind when anchored, thus reducing the potential for contamination from the boat or motor.

**2** It is important that a temperature profile be measured at every metre of depth. This will determine the status of the water body and establish at what depth the samples should be collected.

**3** When the water body is completely mixed (uniform temperature), samples should be collected at mid-depth. However, when a temperature profile exists, samples should be collected mid-depth for each layer (you should then record the depths of the major stratified zones- epilimnion, thermocline, hypolimnion).

*clean samples first*

**4** Water from depth can be pumped to the surface (Geopump Sampler or Master Flex) or collected via grab sample at depth (Van Dorn/Kemmerer Depth Samplers). Once the Van Dorn sample bottle (Figure 4) has reached the appropriate depth, a messenger is released to activate the sampler and to trigger both ends of the sampler to close. This ensures that the sample is collected at exactly the correct depth as per the study design. After sampling, all samplers should be rinsed thoroughly and any plants, animals or mud removed at site before the equipment is deployed in another water body. Sampler cleaning ensures that aquatic invasive species will not be transferred to new water bodies.

**5** When sampling from a boat, it is important that the “clean” principle of sample collection be used. This means that all surface water samples are collected first. The process then

moves to sampling at depth, this process will eliminate the possibility of contamination from the field measurements. (it usually takes some time for the field meters to find equilibrium). Samples are collected at increasingly deeper levels, shallow to deep. Once the sample has been collected in the Van Dorn bottle (see below) it is raised to the surface and a hose is attached to a drain valve this removes the water sample from the Van Dorn bottle and fills the laboratory sample bottles. Filtered samples should be completed on shore.

### **Protocol for a Peristaltic Pump**

**1** Lower the inlet tubing with the weight attached to the first sampling depth and run the pump for at least 5 minutes to flush the pumping system. Run longer if using long tubing to ensure tube is well flushed.

**2** Do not touch the sample bottles with the sampler tubing. Fill the bottles with the sample water from each appropriate depth. Ensure any laboratory requirements for head space and specific parameter requirements are met.

**3** Lower the inlet tubing to the next sampling depth - run the pump 1 minute for each 10 m of tubing, before filling bottles.

**4** When filling Winkler DO bottles place the outlet tube at the bottom of the bottle, rinse the bottle three times with the total volume of water in the bottle, and slowly remove the tube to prevent any aeration and stopper.

**5** Collect samples at identified intervals, stopping at 1 m above the bottom. After all depths have been sampled, raise the pump intake hose above the lake surface and run the pump until the tubing is empty.

**6** Shut the pump off and store appropriately.

### **Protocol for a Van-Dorn or Kemmerer sampler**

Only use Van Dorn (Figure 5) and Kemmerer samplers for lake sampling sites > 2 m in depth and > 1 m in depth, respectively. Ensure that the Van Dorn/Kemmerer sampler is functioning properly. Do not touch the inside of the sampler body or end plug. Store the sampler in the open position in a clean place. Calibrate and mark the sampler line starting from the mid-point of the sampler tube to ensure correct water sampling depths.

**1** Ensure the sampling bottle is clean (rinse bottles three times if not pre-washed) and then open the sampler by raising the end seals. Set the trip mechanism and lower the sampler to the desired depth.

**2** Send the messenger down to “trip” the mechanism that closes the end seals. Raise the sampler to the surface.

**3** Allow a small volume of water to pass through the outlet tube to flush the drain valve. This further reduces the possibility

of contamination with water from the previous depth. If collecting Winkler titration field samples, pour off the Winkler DO samples the first time a given depth is sampled to prevent future aeration. When filling Winkler DO bottles place the outlet tube at the bottom of the bottle, rinse the bottle three times with the total volume of water in the bottle, and slowly remove the tube to prevent any aeration and stopper.

*flush drain valve*

**4** Continue to transfer the water sample from the Van Dorn bottle to individual sample containers via the drain valve. Avoid contact with the drain spout to prevent contamination.

**5** Collect water samples at the required depths down to 1 m above the lake bottom repeating the above steps. Always work from the top to the bottom of the water column.

**Other sources**

ISO (2008 a), Newfoundland and Labrador Environment and Conservation (1999), Environment Canada (2009), Nova Scotia Department of Environment and Labour 1996, ISO 1987

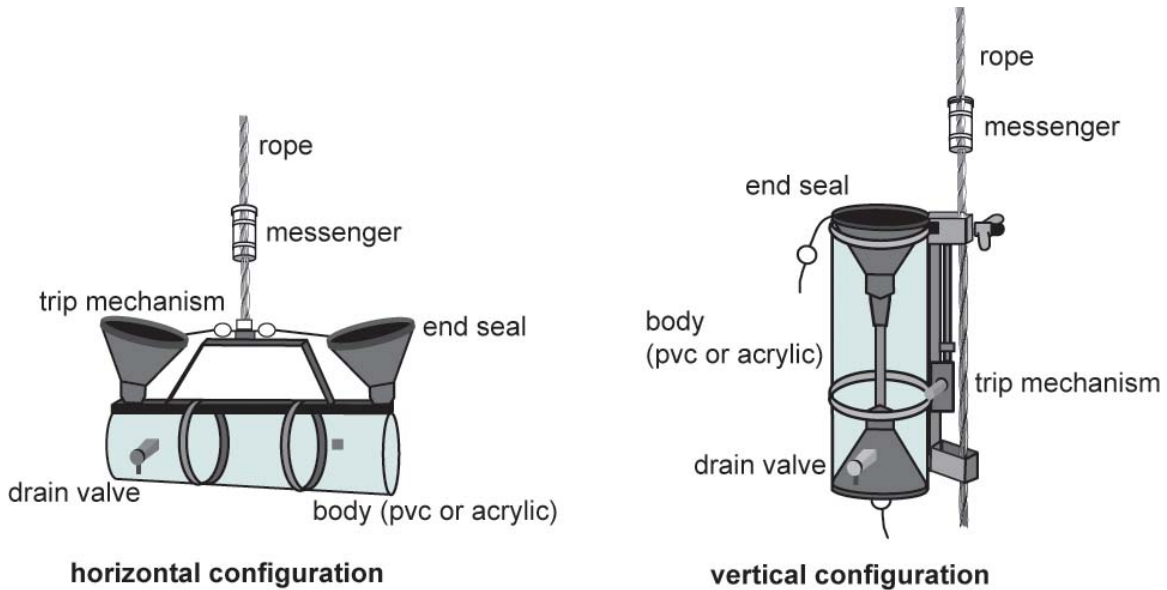

Figure 5. Van Dorn depth water sampler – horizontal and vertical configurations (MWLAP 2003)

## 6.2.5 PROTOCOL FOR SAMPLING FROM SHORE

<b>Overview</b>	Quality assurance and control measures (see appropriate Protocol) and safety issues (see appropriate Protocol) should be adhered to. The Protocol identifies how samplers should sample from the shore, where the sample should be collected, and how to minimize the potential for sample contamination when collecting a sample.
<b>Sources</b>	Environment Canada and B.C. WLAP (2005), Saskatchewan (Undated), B. C. WLAP (2003)
<b>Special safety concerns</b>	Ensure all safety policies are adhered to when sampling from shore, all appropriate safety gear should be worn (i.e. personal flotation device). In some cases, the sampler should also be tethered to either another person or a stable object.
<b>At a glance</b>	<p><b>1</b> Sampling from shore is not applicable in lakes. A sample taken near the shore in a lake will not be representative of the entire lake system.</p> <p><b>2</b> Often, it will not be practical to use a multi-sampler from shore due to the shallowness of the water. In such cases, use an extension rod that will hold the sample containers. When using a sampling rod, ensure to rinse the clamp end of the rod in the stream to reduce possible contamination from a previous site.</p> <p><b>3</b> If the laboratory requires bottles to be pre-rinsed, this should preferably be done at a site slightly downstream from the actual sample location, this prevents contaminants from entering the actual sample bottle.</p> <p><b>4</b> When sampling from shore, always collect water samples facing upstream, this ensures that any contaminants on the sampler do not flow into the sample container. Fill individual bottles one at a time by uncapping the bottle immediately before sampling.</p> <p><b>5</b> When sampling from a rocky outcrop, ensure that the multi-sampler or any type of physical sampler is submerged and the bottles are completely filled.</p> <p><i>sample away from bank</i> <b>6</b> Sample into the current, away from the stream bank. If for some reason the water body appears to be stationary, submerge the bottle beneath the surface away from the sample location until it is filled. Stationary water bodies should be avoided when sampling, they do not provide a complete sample of the environment.</p>
<b>Other sources</b>	ISO (2008 a), Environment Canada Undated (a), Ontario Ministry of the Environment (2006), Newfoundland and Labrador Environment and Conservation (1999).

## 6.2.6 PROTOCOL FOR SAMPLING BY WADING

### Overview

This Protocol identifies how samplers should enter the stream, where the sample should be collected, and how to minimize the likelihood of sample contamination when collecting a sample (Figure 6).

### Sources

Environment Canada and B.C. WLAP (2005), EMAN-N (2005), Ministère de l'Environnement, Gouvernement du Québec (2000)

### Special safety concerns

Wading into a body of water is sometimes a necessary method to collect a water sample. However it can be hazardous. Different types of stream bottoms can pose hazards. Bedrock bottoms are smooth and could potentially be covered with algae which can be slippery. Clay bottoms can be deceiving due to the fine nature of the sediment/silt. There is the risk of the sampler sinking, sometimes several inches into the clay. Large rocks or logs can litter the stream bottom, and coupled with low visibility can become a tripping hazard. Deep, fast water is unsafe to enter. It can be hard to maintain balance in fast water, care must be taken when entering this environment. Any samplers who are in these situations should take swift-water training and adhere to all water safety policies. Shallow, fast flowing waters can potentially pose a risk to samplers. If samplers are lulled into a sense of security, they may become careless or take risks, and it is just as easy to slip in these conditions. When wading for a sample, always ensure a personal flotation device is worn, enter the stream/river in a perpendicular manner and face upstream when ready to take the sample.

### At a glance

- 1** Sampling from shore is not applicable in lakes. A sample taken near the shore in a lake will not be representative of the entire lake system.
- 2** Explore the streambed for large obstacles or holes if unfamiliar with the stream. Be observant and note if the stream/streambed changes at times. Wade carefully into the stream with a wading stick and safety line. When sampling during winter months, be aware of large ice pans that could knock you off balance or trap you. In colder temperatures, care must be taken when walking on rocks due to the formation of ice on the rocks and other surfaces.
- 3** Once you are comfortable and assured that it is safe, sampling can begin. When wading to sample, always collect the sample while facing upstream, this ensures that contaminants that may be on the sampler do not flow into the container.
- 4** Always sample into the current away from the stream bank.
- 5** If the laboratory requires the bottles be pre-rinsed, complete it at a site downstream of the actual sample location. This will

*ascertain  
that the  
streambed is  
safe*

prevent contaminants from entering the sample bottle. Remove the lid from the bottle and hold it without touching the inner surface.

**6** If for some reason the water body appears to be stationary, submerge the bottle beneath the surface away from the sample location until it is filled. Stationary water bodies should be avoided when sampling, they do not provide a complete sample of the environment..

**7** Samples should be collected in the “clean-first” mode. For example bacteriological samples are extremely sensitive to contamination and should always be collected first before any bottles are rinsed.

**8** Grasp the bottle well below the neck. Plunge it beneath the surface in front of you with the opening facing directly down then immediately orient the bottle into the current. Avoid collecting surface scum and film.

**9** Once the bottle is full, remove it from the water by forcing it forward (into the current) and upwards.

## Other sources

B. C. WLAP (2003), ISO (2008 a), Ontario Ministry of the Environment (2006), Newfoundland and Labrador Environment and Conservation (1999), New Brunswick 2000, Saskatchewan (Undated)



Photo 6. Wading and sampling (Environment Canada, B.C. WLAP 2005)

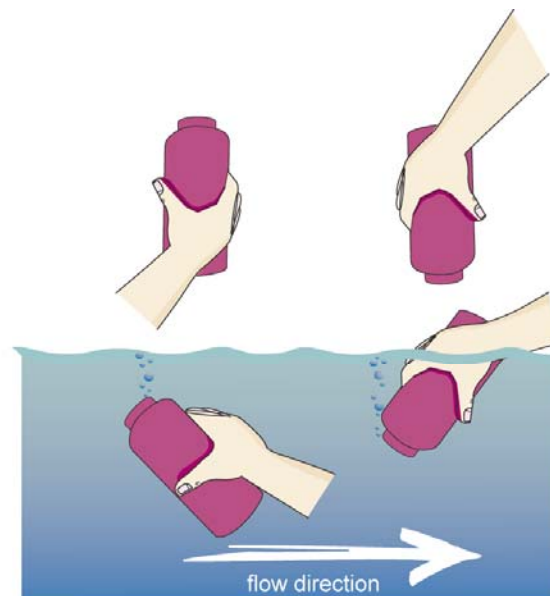

Figure 6. Procedure for collecting sample (Source: Ministère de l'Environnement, Gouvernement du Québec (2000))



## 6.2.7 PROTOCOL FOR SAMPLING WITH USE OF A MULTI-SAMPLER

### Overview

The multi-sampler (See examples in Photo 7 and Figure 7) is an option for collecting several sample containers at one time. This ensures that the equivalent mass of water is collected for analyses at the same time.

### Sources

Environment Canada and B.C. WLAP (2005 c), Ministère de l'Environnement, Gouvernement du Québec (2000), Environment Canada (2003 c)

### At a glance

*each bottle has a designated position*

**1** The multi-sampler should be rinsed at least once in the site water to remove any loose dust/debris and contaminants. Once rinsed load the sample bottles.

**2** Loosen the caps on the bottles when placing them in the sampler. Each bottle has a designated location in the sampler, it is secured by the sampler top and the opening should be above the top surface.

**3** Assemble the sampler (including the lid, handle and rope, as necessary). Ensure to remove the caps from the bottles just before sampling. If applicable, place the tops in the plastic bag to keep them free from contaminants.

**4** The lid from the multi-sampler prevents dirt/water from the rope, from entering the sample after collection. Please note that during high flow, the lid may cause substantial drag.

**5** The sampler Plexiglas top should fit well over the bottles and the holes in the top should be aligned with the upright posts of the sampler. Ensure that the handle is securely tightened, it may twist off in swift currents.

**6 Collecting Replicate Samples:** Collect an additional sample in exactly the same manner and location as completed for the initial (regular) sample. Ensure there is no floating debris to disturb the sample. Add preservatives to applicable bottles.

**7 Field Blanks:** **These should be processed first (i.e. before regular or replicate samples) to ensure that no potential contamination occurs from any residual river water that may remain on the sampling equipment.** Remove bottles containing water from kit and place in sampler in the normal manner. For example, if bottles are loaded on the bridge then load the field blanks on the bridge as well.

**8** When ready to process the blanks, remove the caps from the bottles and store them in a plastic bag. Lower sampler to the surface of the water body (approximately 1 metre above the water's surface if sampling from a bridge).

**9** Bring up the sampler, and replace the caps. Preserve the blanks as normal for regular samples, if required. Complete the data card as usual. Store the multi-sampler in a clean container.

**10** Re-pack the sampling kit in the normal fashion and ship it to the laboratory along with the regular and replicate samples.



Photo 7. Assembled multi-sampler (Environment Canada and B.C. WLAP (2005 c))

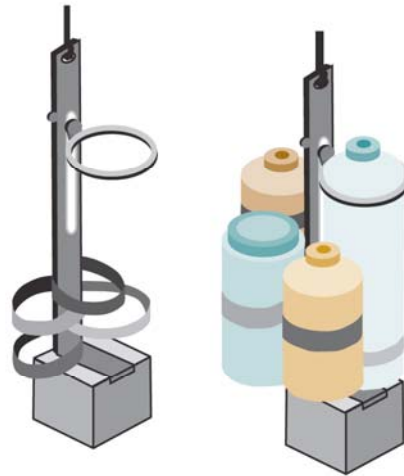

Figure 7. Multi-sampler (Source: Ministère de l'Environnement, Gouvernement du Québec (2000))

## 6.2.8 PROTOCOL FOR COMPOSITE SAMPLING

### Overview

Composite samples can be composed of individual sub-samples collected at different times or depths. The samples are then made into one sample using approximately equal volumes of sub-samples. In the case of a flow-proportional sample, the volumes of the sub-samples are determined in relation to the flow at the time the sample is collected (relative to the total time represented by the composite sample). Such a sample provides an estimate of average water quality.

### Sources

Alberta Environment (2006 a), BC WLAP (2003)

### At a glance

Where the composite sample is comprised of grab samples, the following procedure should be adopted for grab sampling at each specific location.

**1** A pre-cleaned intermediate sample bottle should be rinsed with sample water prior to final collection or according to laboratory instructions. Submerge to required depth, uncap and fill bottle, ensure that the bottle is recapped at depth (to avoid contamination). If specified by the laboratory, repeat this procedure twice more before filling the container and recapping at depth.

**2** During sampling avoid submerged vegetation and try to ensure the sample is free of obvious foreign material. Obvious foreign material is not representative of the water column (e.g. algae, sediment, organic matter, etc.).

*use  
intermediate  
container*

**3** Once sample is collected pour it into the composite sample bucket (pre-cleaned as per laboratory instructions). Continue to collect water samples filling the bucket until sufficient composite volume has been collected (do not rinse again). Keep the bucket covered during sampling to prevent any contaminants from entering the water.

### Other sources

ISO 1987

## 6.2.9 PROTOCOL FOR COLLECTING INTEGRATED AND/OR COMPOSITE INTEGRATED SAMPLES

### Overview

The collection of a sample across a range of depths using equal volumes of sub-samples is referred to as depth-integrated sampling (e.g. spanning the euphotic zone). Composite integrated sampling is the collection of approximately equal volumes of sub-samples at various depths and sites, The samples are then pooled to form a single composite sample. Such a sample accounts for horizontal and vertical spatial heterogeneity and provides an estimate of average water quality. It can be used at several sites in a lake (area-integrated) or several sites across a stream (cross-section). The protocol detailed relates to the use of a sampling tube; however a Van Dorn or a Kemmerer sampler can also be used.

### Sources

Alberta Environment (2006 a), Environment Canada (2009), US EPA (2005)

### At a glance

Composite integrated samples can be made of individual grab samples. Ensure that the samples are collected according to the applicable protocols (e.g., Kemmerer sampler, multi-sampler, etc.) These samples can also be collected using a sampling tube as described below.

**1** When collecting a composite integrated sample using a tube, rinse the sampling tube, sample bucket and lid three times with sample site water.

**2** Place the sample bucket in a light proof container (or black plastic bag) to reduce light penetration and associated phytoplankton chlorophyll production. Place the open end of the sampling tube in the hole in the sampling bucket lid.

**3** Lower the weighted end of the tube slowly (approx. 1 m per sec.) and vertically through the euphotic zone. If the depth of the sample site is less than the depth of the euphotic zone, only sample to within 1 m of the bottom.

*check for sediment*

**4** Pull the tube up into the boat. Check for sediment in the water sample before it leaves the tube. If there is no sediment in the tube, invert the foot valve and drain the water into the sample bucket. If there is sediment in the tube, discard the sample, rinse the tube 3-5 times with lake water, move the boat a few metres, and repeat the haul to a shallower depth. If sediment gets into the sample bucket, discard the sample and start over.

**5** Ensure that the sampling tube and bucket are well cleaned and rinsed.

### Other sources

ISO 1987

## 6.3 PROTOCOL FOR MONITORING FOR PHYSICAL CHARACTERISTICS, NUTRIENTS, IONS, AND METALS IN GRAB SAMPLES

### Overview

This protocol outlines the general procedures for collecting a grab sample. Following this protocol will reduce the risk of contamination and ensure that the sample is collected safely.

### Sources

Environment Canada and B.C. WLAP (2005 c), Environment Canada (2006 b), Alberta Environment (2006 a)

### At a glance

#### *bottle usage*

**1** Only use sample bottles provided by the analytical laboratory specific for each analysis. Reject any uncapped bottles (especially those for analysis of trace metals and other contaminants). Ensure there is always at least one extra set of bottles on hand. When sampling store caps in a plastic bag.

**2** Ensure bottles remain capped until sample collection and are stored under clean conditions (e.g., in cooler, plastic bag, etc). Vehicles should also be kept reasonably clean to limit potential contaminant sources.

#### *do not touch cap or inside of sample bottle*

**3** Only leave the sample bottle uncapped while rinsing (if rinsing is required), filling the bottle and/or adding preservatives. Do not touch the cap liner or the inside of the sampling bottles (even when wearing gloves). Only the water sample and the preservative should touch the inside of the sampling bottle or the cap.

**4** Review the documentation accompanying the sample bottles. The documentation should refer to sample collection, storage and transport requirements. If necessary consult with laboratory personnel regarding any specific instructions. If samples are to be submitted close to or on the weekend, make arrangements with the laboratory to ensure sample holding times are still enforced.

#### *read MSDS*

**5** Ensure all preservatives are sealed and within the marked expiry date. Add preservatives to samples in an area away from potential sources of contamination (e.g., roads and car parks [dust and hydrocarbons]). Become familiar with the MSDS for all preservative chemicals. When handling the preservatives always wear safety glasses and gloves.

#### *collect samples at bow of the boat*

**6** Samples should always be collected at the bow of the boat. If anchored from the bow of the boat, position the bow upstream. This reduces the potential for contamination in the sample from the motor or the boat itself. Ensure the sample is collected in good flow, not in an eddy or backwater. When grab sampling, face upstream to avoid any stirred-up sediment and sample below the water surface.

**7** When not in use, keep all sample collection equipment in sealed clean plastic bags or in a clean cooler.

#### *no smoking*

**8** Sampling personnel should wear un-powdered latex or

*or eating* polyethylene disposable gloves while collecting water samples and refrain from smoking or eating. If gloves are not worn, jewelry and watches should be removed. Do not use insect repellent if sampling by hand or be very careful that insect repellent does not come into contact with the samples.

**9** While sampling avoid submerged vegetation and ensure sample is free of obvious foreign material not representative of the water column at time of sampling (e.g. algae, sediment, organic matter, etc.). Cap tightly and store the water samples at 4°C in a closed cooler for transport.

**10** Filter and/or add preservatives immediately or as soon as possible after sample collection. If the samples are to be laboratory-filtered, ship them as soon as possible. Ensure the samples arrive at the laboratory well within the specified hold time for un-filtered and un-preserved samples.

## Other sources

B. C. WLAP (2003), ISO (2008 a), Ministère de l'Environnement, Gouvernement du Québec (2000), Environment Canada Undated (a), Environment Canada (2008 draft), Ontario Ministry of the Environment (2006), Newfoundland and Labrador Environment and Conservation Newfoundland and Labrador Environment and Conservation (1999), Environment Canada (1999) draft, New Brunswick 2000, Saskatchewan (Undated), EMAN-N (2005), Environment Canada (2009), Nova Scotia Department of Environment and Labour 1996, Environment Canada (2003 a)

## 6.4 PROTOCOL FOR SURFACE LAYER SAMPLING

### Overview

The surface micro-layer has been defined as the top layer of surface waters, approximately 50 microns thick. The micro-layer is important for aquatic habitats, as it is used by many species as their “nurseries” for egg and/or larval forms. Surface layer sampling is conducted to determine the presence of trace organic contaminants in surface films present in surface waters. The surface micro-layer can also be an area of high contaminant concentrations. A wide mouth vessel can be used to collect surface films. Efforts should be made to collect the sample using only 100 to 200 mL of dichloromethane (DCM) since too much DCM hinders analytical recovery of the contaminants. Drum rollers can also be used.

### Sources

ISO (2008 a), BC WLAP (Undated)

### Special safety concerns

Avoid coming in contact with DCM it may cause irreversible health effects. Ensure you have read the MSDS and use appropriate personal protective gear.

### At a glance

#### Grab samples

- 1** Label bottles with the site name, sample date and sample type.
- 2** Do not rinse bottles. Do not touch the inside of the lid or bottle mouth.
- 3** Wearing suitable safety gloves, rinse the Teflon funnel with DCM from the squirt bottle. Catch all waste DCM into a closed container.
- 4** Hold the glass plate by the handle and rinse the other side of the plate using DCM from the squirt bottle. Clean entire area of glass plate and capture all waste DCM into a closed container.
- 5** Gently lower the glass plate until it comes in contact with the surface of the water. The plate and the water surface will form a natural adhesion. Hold plate to the surface for a fraction of a second then remove from water’s surface. Be careful not to submerge the plate below surface.
- 6** Insert Teflon funnel into trace organic bottle.
- 7** Rinse glass plate with DCM squirt bottle into the Teflon funnel. Rinse entire surface area of the glass plate collecting all the DCM into trace organic bottle. Collect about 100 mL – 200 mL of DCM.

*keep glass plate on water surface*

#### Drum roller

- 1** A drum roller can be employed over the side of a boat adjacent to the aft deck upstream from the vessel’s outboard motor.
- 2** Set the boat forward at a speed of between 2 and 3 knots to equal the drum speed and to minimize wave action on the

sampler. This speed may have to be varied depending on the actual sample conditions.

**3** Hold the sampler off the hull of the vessel and apply pressure to the tray scraper of the rotating drum (Photo 8).

**4** Estimate the area traversed in sampling. Do not cut across an earlier path of the vessel to avoid contamination from the vessel motor.



Photo 8. Use of drum roller  
(Source: B.C. Ministry of  
Environment (Undated))



## 6.5 PROTOCOL FOR AUTOMATED SAMPLING (MULTI-PROBES)

### Overview

*In situ* measurements of variables such as pH, DO (dissolved oxygen), temperature, conductivity, and turbidity are routinely taken automatically over time (long-term deployment). Typically, the data are collected using multi-probe instruments called sondes that are positioned at mid-depth in rivers and streams. Long-term deployment of a multi-probe system provides an almost continuous record of temporal changes in parameters that can be used for a variety of purposes. Weather may limit year-round operations for some automated stations in Canada.

The location of each potential site depends on the purpose of the study, accessibility, safety, stream morphology, seasonal flow patterns and cross-section variability. All automated water-quality sampling stations must be accessible (near a road or by aircraft such as, helicopter), safe (shallow sloping banks), and have a minimal chance of being damaged or destroyed by natural forces (windfall of trees, snow pack and ice). Protection from vandalism is imperative. In general, the three components to keep secure are the sonde (use protective deployment tube), the accessory equipment (data logger, batteries, and additional power sources), and the cables.

There must be a pool of water removed from riffle areas in which the sensor can be deployed. A straight stretch of stream above and below the sampling location is required to minimize the cross-sectional variability. During high flow periods, the instruments may be removed from the stream. The variation in the water chemistry across the stream at the sampling site should be determined before the station is established.

### Sources

B.C. Ministry of Environment (2006), United States Geological Survey (2006)

### Special safety concerns How they differ

Refer to the Protocols for working near swift water and working in remote areas

The reader is referred to the actual references cited because the protocols for different situations and types of equipment can vary significantly and the detailed procedures for operating these stations are beyond the scope of this manual. This manual provides only a general overview of techniques.

### At a glance

#### Components

**1** Equipment used in automated sampling has three parts: the sensors used to collect the data; the accessory equipment which

includes a combination of a data logger, power source and a means of retrieving the data; and the cables and adapters. These individual parts must work together and be protected.

**2 Sensors** (electrical, electrochemical, or optical) respond to changing water conditions with an output signal that is processed, displayed and recorded. The choice of sensor depends on the parameters, the required specifications, the operating conditions and required life span. Several sensors are usually contained in a multi-sensor sonde (Photo 9).

**3 Data loggers** may be contained within a sonde or connected externally. Data filtering and processing is completed within the data loggers. The time interval of the recorded samples is determined by the user. The duration of individual samples is a function of the sensors.

**4 Possible sources of power** are internal batteries (which are contained within the sonde), external batteries and solar panels (used for satellite transmission). **Cables** (instrument and site-specific) connect the external batteries to the sonde or the solar panel to the external battery. The connection process is not addressed in this manual. Depending on the capacity required (amp-hours); external batteries should be a good quality gel-cell type, or a deep discharge sealed lead-acid style. Residential (110V) and solar power sources can be used as auxiliary power to the primary battery for recharge purposes. Residential and solar power sources should not be directly connected to an instrument, as voltage spikes can occur and cause the entire system to fail. Use of a voltage regulator is recommended when connecting an auxiliary power source to the primary battery.

**5 Communication and data retrieval** can be done on-site with a laptop or hand-held display. Data retrieval can also be achieved remotely in real-time using phone or satellite communication.

**6 Deployment** refers to the way that the sensor comes into contact with the ambient water. There are two main deployment methods. The sensor is either placed in the stream or the stream water is brought out of the stream to the sensor. The former is called an *in situ* or in-stream system and the latter is called a "flow-through-system" or a side-stream system. With *in-situ* systems the sensor may be placed in tubes that are fixed vertically or positioned at an angle to the stream bank, or contained in a retractable boom (Figure 8). This reduces the movement of the instrument and the possibility of it being swept away in high flow.

### Monitoring basics

*frequency of* To ensure the integrity of the data being recorded, all multi-probes must be serviced. During the servicing, the stream data can be downloaded and collected for analysis and review.

### *field visits*

Servicing an instrument is completed during a field visit.

**1** The frequency of the field visits depends on the stream conditions. New sites should be visited every two to three weeks. At sites where there is no remote real-time communication, the frequency should not be greater than the longest period of data that the operator is willing or allowed to lose. Some remote areas can be visited every 30 days.

**2** Field visits include procedures to be undertaken on-site and/or in a stable environment (sheltered area with a stable temperature for working and storing calibration standards).

**3** A cleaned portable sonde is used for comparison against the deployed field sonde. The portable sonde must be within the same specifications as the deployed sonde. There is the possibility that during deployment the parameter sensors become fouled, drift out of calibration or malfunction resulting in sensor error. (See source manuals). During transport of sondes, the parameter sensors must be kept from drying out and should be kept moist.

**4** A list of field supplies should be prepared and consulted prior to and during each field visit.

**5** Laboratory samples for some parameters (specific conductivity, dissolved oxygen, pH and temperature are field-measured variables) may be required. Several jurisdictions collect samples on each site visit. Other jurisdictions do not routinely collect samples and base the findings on the multi-sondes. This is acceptable if the data is obtained from sensors that are inspected and calibrated routinely.

### *minimize bubbles*

**6** Stream turbulence can produce bubbles that interfere with the readings on optical sensors (e.g., turbidity and chlorophyll-*a*). However wipers present on these sensors can remove the bubbles, this reduces the risk of an error reading. If the sensor does not have a wiper, angle deployment is preferred to prevent bubble accumulation.

**7** The sensors must be placed effectively within a water column. It is important to ensure that there is a minimum distance from the surface, as this will eliminate the effects of solar radiation. There should also be a minimum distance from the substrate to avoid effects of bedload transport.

### **Recommended protocol**

When cleaning or calibrating a multi-probe, ensure access to a temperature stable and protected location. Some chemical standards used to calibrate the multi-probe are temperature-sensitive and it is always important to reduce the likelihood of contamination. In most cases, the data is collected at the field site. Pre-cleaning data can be collected in stream water at the field site. The post-cleaning data can be collected in stream water transported to the stable environment away from the field

site (this may not be possible for all sites) or during re-deployment. To ensure the changes occurring during the transport of stream water are captured, each reading with the deployed (D) sonde is paired with a reading of the portable (P) sonde. The readings of the portable sonde are used to determine the change in the stream water during its transport from the stream to the stable environment.

**1** Before a site visit, organize necessary field supplies, calibrate applicable portable sonde and ensure that the required laboratory supplies are available. In the very first site visit the deployed instrument will also have to be calibrated and prepared for long-term deployment.

**2** At the field site, inspect the site for damage to equipment or any applicable changes to deployment site (i.e. high flow, turbid water). The logged deployment data can be downloaded. Compare the portable sonde against the field deployed sonde *in-situ* or from “a bucket of stream water”. If applicable collect stream samples. Clean the deployment tube of any debris or sediment that may be caught inside. Transport the sondes to a stable location for complete calibration and clean.

**3** When the instrument is removed to a stable environment for calibration and cleaning, firstly inspect the condition of the sonde and its sensors, clean the instruments’ sensors as specified by the manufacture. Place the instrument "in a bucket of stream water" and record all data. Continue with calibration, record information on calibration standards, collect the calibration drift data (measurement in calibration solution prior to re-calibration), and calibrate (using standard calibration standards) or if necessary replace the sensors. Wrap the guard in a damp towel or replace the guard with some water in the calibration cup or with a moist sponge on the bottom of the calibration cup. Put the cap/plug on the sonde to protect the electronic connections and prepare the sondes for transport to the field.

**4** The difference between portable sonde readings is a result of changes occurring in the natural environment of the stream. The difference in deployed sonde readings is the calculated difference due to fouling. The amount due to fouling is obtained by subtracting these two differences.

**5** When re-deploying the field instrument, record the re-deployment data firstly "in a bucket of stream water”, and then *in situ*. Each new sampling period starts with freshly calibrated and cleaned sensors to minimize sampling drift during the deployment period.

**6** After each field visit data grades or ratings are calculated.



Photo 9 Left. A sonde with a number of probes and a wiper (Source: B.C. B.C. Ministry of Environment (2006))

Photo 10 Right. Slotted deployment tube (top view on right - prevents access to sonde and sensors and helps support sonde) (Source: B.C. Ministry of Environment (2006))

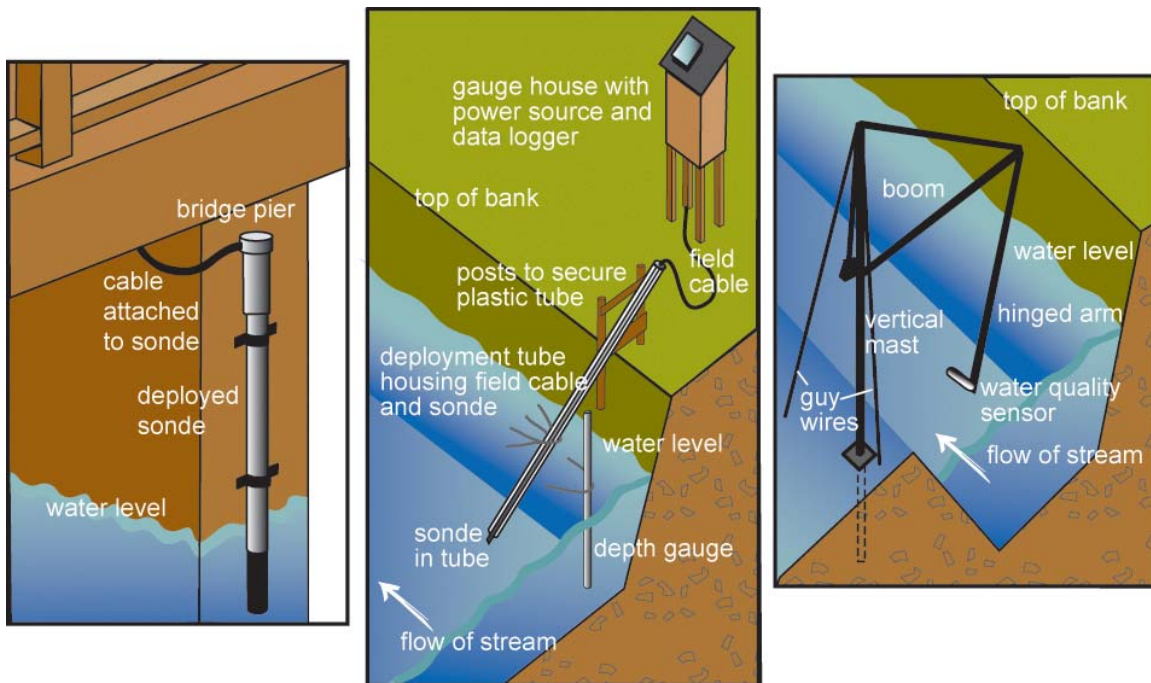

Figure 8. Deployment tubes (from left to right: vertical, angle and retractable boom) (Source: B.C. Ministry of Environment (2006))

## 6.6 PROTOCOL FOR BACTERIOLOGICAL SAMPLING

### Overview

Samples are typically analyzed for a combination of the following bacterial parameters: total (rarely) and fecal coliforms, *Escherichia coli* (*E. coli*), fecal streptococci, and enterococci. Due to the high risk of potential contamination of the sample during collection, care must be taken when collecting bacteriological samples to ensure sterile conditions. Sample containers should be filled as per laboratory instructions and samples should be kept out of the light and chilled on ice (do not allow to freeze). Always collect bacteriological samples first, if sampling from a boat, obtain the sample from the upstream side of the boat.

Bacterial samples are time-sensitive; it may not be possible to transport samples to a laboratory for analysis in time. A mobile bacteriological water quality kit can be purchased from suppliers and can be used to analyze total coliform, fecal coliform, *E. coli*, and fecal streptococci. The kit comes with two incubators that can plug into vehicle cigarette lighters, a binocular microscope, Petri dishes, squared filter paper, media, filtration equipment, sterilizing alcohol, and flame.

### Sources

Environment Canada and B.C. WLAP (2005), Alberta Environment (2006 a), EMAN-N (2005)

### Special safety concerns

The sampler should not exceed a depth where there exists a reasonable possibility that water might unexpectedly enter the gumboot or hip-wader. Ensure any safety policies are adhered to when sampling, including all appropriate safety gear worn (i.e. personal flotation device). In some cases, the sampler should also be tethered to either another person or a stable object.

### At a glance

#### Beach/shore sampling

**1** Wade out to knee deep water, aiming for beyond the point where wave action affects the lake bottom (avoid contamination by suspended sediments). Avoid disturbing the sediment/substrate. Wait 2 to 3 minutes to ensure any sediment disturbed by wading has settled.

**2** Always hold bottle upright and by the base. Keep sample bottle closed until needed. Holding the bottle upright and by the base, in one continuous motion submerge till the bottle opening is approximately 30 cm below the water surface or other specified depth, facing towards the current.

**3** Uncap and fill the sample bottle as required by the laboratory, cap and bring to the surface. Immediately place the bottle in a closed cooler with ice packs or hot water bottles,

depending on the season.

**4** If necessary, sample bottle can be filled from a clean (sterile) intermediate container.

**5** Take several individual samples along the length of the beach.

### Sampling from boat

**1** Sample from the bow of the boat to prevent potential contamination from the boat or the outboard motor.

**2** Keep sample bottle closed until needed. Take a sample at arms length from the boat and sample facing towards the current (the direction the boat is facing). Always hold bottle upright and by the base. In one continuous motion submerge till the bottle opening is approximately 30 cm below the water surface or other specified depth.

**3** Uncap and fill the sample bottle as required by the laboratory, cap and bring to the surface. Immediately place the bottle in a closed cooler with ice packs or hot water bottles, depending on the season.

**4** If necessary, the sample bottle can be filled from a clean (sterile) intermediate container.

### Sampling at depth

**1** Sample from the bow of the boat to prevent potential contamination from the boat or the motor. Ensure that the person in the stern is providing counterbalance (working over the opposite side of the boat).

**2** Collect a sample of water at the desired depth with a depth sampler.

**3** Do not rinse the bottle or touch the inside of the bottle or cap, and always hold bottle upright and by the base. Keep sample bottle closed until needed.

**4** Fill the sample bottle as required by the laboratory and immediately cap the bottle securely.

**5** Immediately place the bottle in a closed cooler with ice packs or hot water bottles, depending on the season.

### Other sources

B. C. WLAP 2003, Newfoundland and Labrador Environment and Conservation (1999), Environment Canada (1999) draft, NB 2000, Saskatchewan (Undated), Environment Canada 2002 (a)

## 6.7 GENERAL PROTOCOL FOR COLLECTION OF WATER SAMPLES FOR LABORATORY BIOASSAYS

### Overview

The physical collection of a sample for liquid phase bioassay testing will vary only slightly between the different bioassay types. The only major difference will be; the volume of material required to complete the requested bioassay(s) and the dilution series. It is strongly recommended that field staff consult the laboratory for confirmation on the amount of liquid required to conduct the requested bioassay(s).

### Sources

British Columbia MWLAP (2003)

### At a glance

- 1** Receiving water should be pumped from the designated sampling depth using clean polyethylene tubing into a clean polyethylene or polypropylene container.
- 2** Containers for storage and transportation of samples must be made of non-toxic material such as laboratory-cleaned glass. The containers must be new or thoroughly cleaned and dried, Rinse the containers with clean water, then with the sample to be collected. The container must be filled with sample to exclude air and then be sealed.
- 3** Labeling must include: sample type, location, date, time of collection, and name of sampler.
- 4** Samples should be kept from freezing. If more than two days are spent in transit samples should be kept dark and at a temperature of 1°C to 8°C.

*use non-toxic containers*



## 6.8 PROTOCOL FOR SAMPLING CHLOROPHYLL-A

### Overview

Chlorophyll-a samples are collected like other samples, either as grab samples or as composite samples. The difference comes in subsequent sample handling, where samples are filtered and the filter is analyzed by the laboratory.

### Sources

Alberta Environment (2006 a), Environment Canada (2009)

### At a glance

Filter using only the apparatus and flask designated for chlorophyll-*a* (do not acid wash). Do not exceed 7 psi or 48 kPa when pumping through a filter. Triplicate filters are required by some jurisdictions.

**1** Rinse the graduated cylinder with distilled/de-ionized water.

**2** Mix the sample for 30 seconds before pouring off the first replicate (if replicates are being used).

**3** For lake samples, filter 50 to 500 mL of sample through a 47 mm GF/C glass filter and record the volume (use tweezers when handling the filter).

**4** For river samples, filter 500 to 1000 mL of sample through a GF/C filter and record the volume. If the water is very turbid, filter what you can through two filters and combine in one tube for submission to the laboratory. Note total volume and "two filters" on field sheet. Filter just enough of a sample to get a light green/brown colour on the filter and do not clog the filter.

**5** Rinse the graduated cylinder and the sides of the filter funnel with distilled/de-ionized water and pass this rinse water through the filter.

*add  
preservative*

**6** After most of the sample has passed through the filter (about 100 mL remaining) add 1 to 2 mL saturated MgCO<sub>3</sub> solution.

**7** Remove the filter and using tweezers, avoid touching it with your fingers as they may have acids on them.

**8** Store the filter in a freezer (below minus 20°C).

## 6.9 PROTOCOL FOR SAMPLING MERCURY

### Overview

Extreme care should be taken when sampling for mercury in the water column. Mercury levels being measured are so low that even a miniscule amount of contamination can impact the results. Extraordinary attention must be given to sample collection.

### Sources

Environment Canada (2006 b), Environment Canada (2008 draft), Saskatchewan (Undated)

### At a glance

*mercury  
samples*

**1** Samples should be collected in pre-cleaned bottles (some jurisdictions use Teflon bottles that are then stored in plastic containers). Use preservatives supplied by the laboratory. The bottles should not be rinsed.

**2** Wearing gloves, fill the bottle according to protocols for grab sample collection. Add necessary preservatives. Invert the bottle after capping to ensure proper mixing of the preservative with the sample.

**3** Alternately, Environment Canada specifies that mercury samples should be collected, wearing gloves and using an ISOMET sampler. This sampler consists of a clamp that holds a specifically cleaned Teflon bottle at the end of a long hollow pole (sampler body). An un-capper above the bottle clamp is attached through the sampler body to a handle at the other end of the sampler. This tool allows the user to grab the bottle lid, to unscrew, open, and re-close the bottle underwater by manipulating the handle and not touching the bottle itself (Photo 11).

**4** Rinse the end of the sampler in ambient water, remove it from the water and open the bottle clamp (with a gloved hand) by unhooking the hinge (Photo 12). Remove a Teflon bottle (in its plastic container) from the cooler, and open the lid of the plastic container.

**5** Using the plastic container (gloved hands if necessary) to position the bottle, place the bottle into the open bottle clamp. Ensure that the ridges along the side of the bottle, line up with the grooves in the bottle clamp and that the point that the ridges end on the bottle is lined up with the bottom of the bottle clamp itself. This will ensure that the un-capper will be able to grasp the bottle lid properly. Also ensure that the bottle is placed into the clamp straight (not crooked) as this could prevent the un-capper from working properly. Once the bottle is in the bottle clamp, close the bottle clamp to secure the bottle, then push the sampler handle down as far as it will go. This will move the bottle un-capper down onto the lid of the Teflon bottle, gripping it tightly.

**6** Holding the sampler by the handle end, submerge the bottle into the water,. Make sure the bottle/bottle clamp assembly is

well below the surface of the water.

**7** To fill the bottle, turn the handle counter-clockwise which will turn the un-capper counterclockwise, unscrewing the bottle cap. After it has rotated a few turns, pull up on the handle, pulling the bottle cap away from the bottle (Figure 12), allowing it to fill with water. When there are no longer any bubbles, the bottle is full. Keep the bottle/bottle clamp assembly in-place under the water, push the sampler handle down to push the lid back onto the bottle, and turn it clockwise until snug to screw the lid back onto the bottle. Once the bottle is full and has been re-capped, pull up on the sampler handle one more time to release the bottle lid from the un-capper. Keep the bottle under the water at this point but move it up close to the surface to verify that the bottle has filled and has been closed properly.

**8** Pull the whole sampler out of the water. With clean, gloved hands, and using the same plastic container that the bottle came in, catch the bottle, unhook the bottle clamp to release the bottle and let it slide into the plastic container. Close the container.

**9** Place the bottle in a cooler and store at 4°C.



Photo 11. ISOMET sampler (Source: Environment Canada (2008 draft))



Photo 12. ISOMET sampler under water (Source: Environment Canada (2008 draft))

## 6.10 PROTOCOL FOR MICROBIAL SOURCE TRACKING

### Overview

Microbial source tracking is a specialized area of determining the source of bacteriological contamination. Numerous approaches have been used to determine potential sources of fecal contamination and these methods are at various stages of development and validation. One method cannot answer all questions and it is likely that this will not change in the near future. This protocol focuses on collection of samples for microbial source tracking (MST). Methods for MST analysis are dynamic with a number of new approaches being developed such as gene chips with toxin genes and/or fecal indicator sequences, and biosensors for the detection of target organisms. Methods currently used for MST fall into two broad categories, genotypic versus phenotypic analysis of either cultivated target organisms, or cultivation-independent approaches by direct analysis of samples from the environment.

### Sources

US EPA (2005)

### At a glance

*collect  
source  
library with  
samples*

- 1** Composite samples are preferred to grab samples in order to include more of the entire cross-sectional area or volume of the sampled water body.
- 2** Taking several replicate samples or compositing samples over time helps to even out short-term variability.
- 3** The existence of transient animal populations implies that the known-source library may not be useful in all seasons. This stresses the need that the known-source library should be collected concurrently with water samples. Different sources of fecal contamination could be expected in storm flow from base flow.
- 4** Collect a sample of water at the desired depth with a depth sampler using precautions to minimize contamination.
- 5** Do not rinse the bottle or touch the inside of the bottle or cap, and always hold bottle upright and by the base. Keep sample bottle closed until needed.
- 6** Fill the sample bottle as requested by the laboratory and immediately cap the bottle securely.

## 6.11 PROCEDURES FOR PHOTOSYNTHETICALLY-ACTIVE RADIATION (PAR) SENSING

### Overview

PAR is a slightly narrower band of radiation (400 – 700 nm) than visible light, and is the area of the spectrum used by plants. The measurement of PAR profiles is undertaken to measure PAR attenuation with water depth. The euphotic zone extends to the depth where the PAR meter records 1% incident radiation.

### Sources

Alberta Environment (2006 a)

### At a glance

*consistent  
light  
conditions*

For best results, PAR should be conducted in consistent light conditions. Ensure that the sun and cloud condition of the sample day is recorded in the field sheet/book. In rough weather, take the 2.5 cm readings just below the trough of the waves. If the waterbody is exceptionally green, stained or turbid (recorded by a Secchi at less than 1 m) take extra light readings at 0.5 m intervals to aid in accurate calculation of extinction coefficients. Sensors should be rinsed with distilled/de-ionized/reverse osmosis water at regular intervals throughout the season and should be periodically sent in to the manufacture for calibration.

- 1** Read the manual and ensure the data logger/display has the proper sensor calibration multiplier stored for the sensor in use.
- 2** Ensure all connections are properly made, remove protective cap from sensor and turn instrument on.
- 3** Take light readings from sunny side of boat and leave sensor at each depth for at least 15 seconds or until stable.
- 4** Record and store readings at 2.5 cm, 10 cm and 1 m intervals to 1 m below the euphotic zone depth (1% of the 2.5 cm reading). If the initial readings drop by more than 50%, use 0.5 m intervals. Readings are in  $\mu\text{m}/\text{sec}/\text{m}^2$ .
- 5** Accurately determine the euphotic zone depth by raising the sensor to 1% of the 2.5 cm reading. Record this depth and sensor number in the lake field sheet.
- 6** Retrieve sensor and carefully repack in the storage case: do not kink the cable.
- 7** Transfer stored data to disc using a communications package.

## 6.12 PROTOCOL FOR SAMPLING PROTOZOA

### Overview

The predominant protozoan pathogens in aquatic systems are *Cryptosporidium* and *Giardia lamblia*, and the presence of these can only be verified by the identification of *Cryptosporidium* oocysts and *Giardia* cysts. Due to the high risk of potential contamination of the sample during collection, care must be taken when collecting protozoan samples. Thus, additional procedures are followed to try and maintain sterile conditions.

### Sources

Alberta Environment (2006 a), EMAN-N (2005)

### At a glance

**1** Set up the sampling apparatus on shore with the intake line placed into the water column midway between the surface and bottom. Hold in-place using an anchoring rod. Care must be used when choosing a site to find good flow and to avoid any backwater areas.

**2** Connect the pump to the battery and open the flow valve for maximum flow. 100 L of source water are pumped to flush the system and check for leaks. The valve is shut off and the pump disconnected from the battery.

**3** Place a cartridge filter aseptically into the filter holder. Tighten the filter holder and place it in the stainless steel bucket to keep it upright. Record a water meter reading and the time. Start the pump and partially open the valve. Adjust the flow rate to 4 L/minute

**4** At least 100 L of water should be pumped through the filter if possible. In water that is very clear additional samples should be pumped (usually 150-200 L). In very turbid conditions pumping continues only until the filter has reached capacity and the water flow has ceased.

**5** Do not allow the pressure to exceed 30 psi. During pumping, the flow rate is adjusted when necessary to try to keep the rate constant.

*watch  
pressure*

**6** When pumping is complete, close the flow valve to ensure no backflow of sample, and then disconnect the pump from the battery. Record the end time and meter reading.

**7** Remove the filter aseptically from the filter holder and put it into a plastic Ziploc bag. The water and any sediment from the filter holder are poured into the bag containing the filter cartridge, seal the bag and put it into a second Ziploc bag to ensure that any leakage will be captured.

**8** Sampling information including site name, date, start and end times, start and end meter readings, total volume pumped, flow rate, maximum pressure, sampler initials, and site sample number should be recorded on the outside bag.

**9** Place the sample into a cooler containing ice packs or hot water bottles, depending on the season. If not transported to the

laboratory the same day, keep refrigerated at 4°C until sent. A 50 – 100 mL water sample for turbidity should also be collected whenever a filter sample is taken.

*cleaning  
sampling  
apparatus* **10** Once sampling has been completed, flush a minimum of 100 L of warm water through the system. The sampling apparatus is attached to the Pony pump and intake line, which in turn is attached to a water tap. Neutrad soap is added at the beginning of the cleaning. The filter holder is scrubbed with a stiff brush in instances where grit was present. Once flushed out and cleaned, the equipment can be left to air-dry.

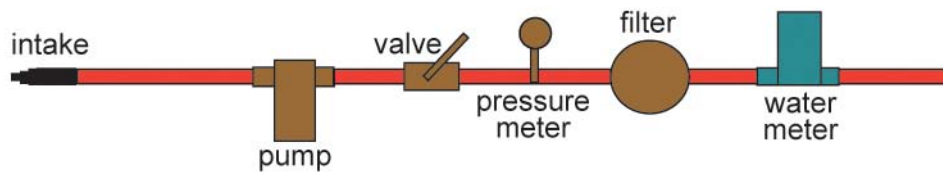

Figure 9: Assembled protozoan sampling apparatus (Alberta Environment (2006a))

## 6.13 PROTOCOL FOR TRACE ORGANIC CONTAMINANTS AND PESTICIDES SAMPLING

### Overview

Trace organic sampling use grab or composite sampling techniques as long as consideration is given to the following points.

- Only glass, Teflon, or stainless steel that are cleaned to trace organic standards, should be in contact the sample.
- Samples should not have any headspace and should be collected in amber or dark glass bottles to limit potential photo-degradation.
- Minimize sample aeration to limit volatilization.
- Avoid using an intermediate container to fill samples bottles (a contamination concern).
- Preserve samples as required by the laboratory.
- When sampling under ice, some vials used for volatile priority pollutants (VPP) are difficult to fill. Ensure the auger hole is well flushed and lower the vials by hand as deep as possible, then cap below the surface. Alternately, a clean trace organic 1L brown bottle can be filled and VPP vials immediately poured off from the 1L brown bottle ensuring no head space.

For blanks, use ultra-pure de-ionized water (highest-grade de-ionized water used in the analysis of the trace organic parameters being sampled) supplied by the appropriate analytical laboratory section for field blanks.

### Sources

Alberta Environment (2006 a), Environment Canada (2006 b), Environment Canada (1999)

### At a glance

- 1** Do not rinse bottles (unless instructed to by the laboratory) and do not touch the inside of the lid or mouth of the bottle.
- 2** Pesticide and AOX sample bottles may be filled from a 4 L polycarbonate bottle (Photo 13).
- 3** In rivers, submerge the bottle directly in the flow facing upstream. Cap below the surface once full. When sampling from a bridge, place bottle in stainless holder with foam insert, keep cap of bottle on until bottle is inserted in place. This avoids the risk of touching the bottle mouth to the stainless holder. Lower into main flow, raise bottle up and down in the flow until full, then carefully remove the holder to bridge level and cap the bottle. When sampling under ice, place bottle in stainless steel holder with foam insert and drop quickly into the main flow below the ice. Cap below the surface when full.
- 4** In lakes, either for open water or under ice, use a peristaltic pump to collect a vertically integrated composite, ensuring that



Teflon tubing is used. Submit a QA/QC pump equipment blank to check for possible contamination.

### Large sample extraction

**1** A benefit of in-field large sample extraction is the reduced detection limits. This is due to the larger sample (20 to 40 litres). Two types of samplers are the Goulden Large Sample Extractor and the Pressure Container sample extractor.

### Pressure container sample extractor

The PCSE is a liquid-liquid large sample extractor, which uses dichloromethane (DCM) to concentrate hydrophobic trace organics. It is not a flow-through extractor, and may be thought of as a larger variation of the separatory funnel extraction technique used in most laboratories. The PCSE offers certain advantages over flow-through systems including simplicity and ease of operation.

**1** Water samples are collected in pre-washed 20-litre stainless steel beverage containers. The samples are filtered under nitrogen pressure through in-line stainless steel holders (142 mm GF-C or AE) into Millipore stainless steel pressure containers for solvent extraction. Alternatively, centrifugate can be extracted, making the filtering step unnecessary.

**2** A known volume of recovery standards (in methanol) are added to the pressure container.

*extract in  
two stages*

**3** Samples are extracted in two stages. An initial volume of 600 mL DCM is added to the pressure container, stirred at slow speed with a stainless steel and Teflon mechanical stirrer for 15 minutes. The DCM is then allowed to settle to the bottom for 15 minutes and forced under low nitrogen pressure into a sample container. Any residual water entering the sample container is poured back into the pressure container.

**4** A second aliquot (300 mL) of DCM is added to the pressure container, stirred for 15 minutes, and allowed to settle for 15 minutes. The second stage extract is then combined with the first stage extract to complete the sample.

**5** At this point, the pH of the sample can be adjusted and the procedure repeated to extract acid or base extractable compounds. The required time for extraction of a 20-litre PCSE sample, including cleanup, is approximately 2 hours.

### Goulden large sample extractor

**1** The sampler and all Teflon tubing are cleaned between surveys using organic-free cleaning protocols including detergent washing, organic-free de-ionized water rinses, acetone then hexane rinses, followed by air drying. Between samples during surveys, the sampler is rinsed with acetone, hexane, and

organic free water between sites, with all glassware openings covered with fired aluminum foil (fired aluminum foil: place aluminum foil in muffle furnace for 3-6 hours at 400°C) when not in use. If possible, surveys are designed to move from sites of lower probable contaminants to higher contaminants to reduce the possibility of cross-contamination.

**2** Samples are collected in pre-cleaned 4-litre glass containers or 20-litre stainless steel beverage pressure containers (all rubber o-rings on the beverage container should be replaced with vitex o-rings). The sample is filtered before extraction to reduce dichloromethane (DCM) emulsion, which can lead to reduced extraction recovery. Filtering can be accomplished by using a Millipore 142 mm stainless steel in-line filter holder and GF-C paper under nitrogen pressure (using a beverage pressure container). The filter paper should be retained (wrap in fired aluminum foil, then in a Ziploc-type bag) for subsequent laboratory extraction. The water and sediment extracts are subsequently combined to provide a result for whole water. An alternative to filtering is to extract centrifugate in the sampler and analyze suspended sediments from the sedi-sampler.

**3** An initial volume of 300 mL DCM (pesticide grade) is added to the mixing chamber, and sample water pumped into the sampler through glass and Teflon tubing at a rate of 500 mL/minute. The sample is heated by a core heater to approximately 20° C to increase extraction efficiency, and mixed by a stainless steel mechanical stirrer. A second pump adds a precise volume of recovery standards (in methanol) to the mixture throughout the extraction process. A third pump replaces DCM, which is lost due to water solubility (1.6%). The pumps and mixer should be stopped periodically during the process to ensure that the DCM level remains near the original 300 mL mark. If the DCM level varies, the makeup rate should be adjusted. The standard should be added until approximately 10 minutes before the end of the extraction process to allow time to rinse the standard container and purge the intake line with an additional volume of analytical grade methanol.

**4** Following extraction, the DCM extract is decanted to 1-litre pre-cleaned amber glass containers using a Teflon separatory funnel (to reduce emulsion). Repeated rinsing of the sampler with extracted water is generally required to remove entrapped DCM, particularly from the packed Teflon column. Any solvent that reaches the third stage settling chamber is added to the extract. DCM lot numbers should be recorded and solvent blanks and method blanks (using organic free water spiked with recovery standards) should be collected at pre-planned intervals. The time required for extraction of a 40-litre sample averages approximately 2.5 hours, allowing time for extraction, sample

recovery, and cleanup.

**Other  
sources**

ISO 2008 (b), Environment Canada Undated (a), Personal Com  
M. Sekela, Environment Canada (2009)

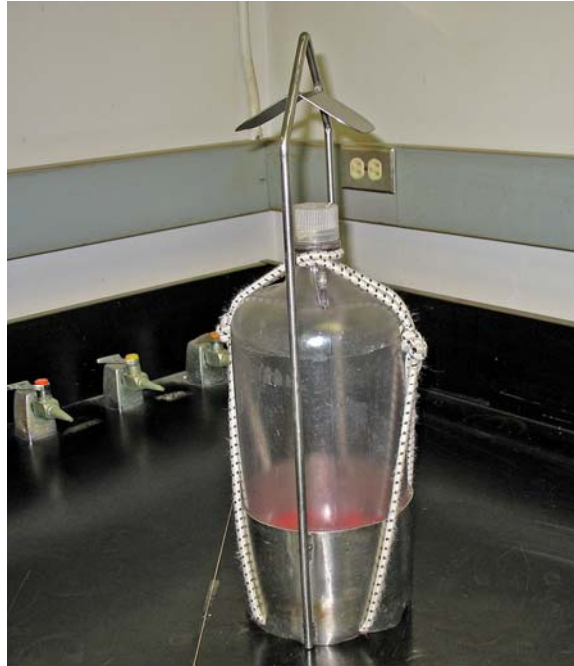

Photo 13: Example of a 4-litre sampler  
(Courtesy: Darcy McDonald, Alberta  
Environment)

## 6.14 PROTOCOL FOR RADIONUCLIDES SAMPLING

### Overview

Radionuclides are usually tested in drinking water systems; however, there are occasions when surface water samples are tested. The origins of radionuclides can be either natural or human-based. Natural radionuclides such as uranium 238, thorium 232, potassium 40, lead 210 and radium 226 may be found in water that is in contact with bedrock and soils. Radon may also be present. Radionuclides from human activities include uranium 235, hydrogen 3 or tritium, cesium 137, strontium 90, antimony 125, lead 210, and plutonium 244. These radionuclides can be released into the environment by mining, bomb tests, crashed satellites, and nuclear power plant disasters, such as the Chernobyl disaster in the Ukraine in 1986.

### Sources

EMAN-N (2005)

### At a glance

**1** Any quantitative analysis for radionuclides will require obtaining a discrete sample. Bottle types and any required preservatives should be determined from discussions with the laboratory that will do the analyses.

**2** If low concentrations are expected, large volumes of water can be collected using large sample extractor techniques in a manner similar to that outlined for collection of trace organics.

## 7.0 PROTOCOLS FOR SEDIMENT MONITORING

### 7.1 PROTOCOL FOR SEDIMENT MONITORING FOR NUTRIENTS, METALS AND PHYSICAL CHARACTERISTICS

#### Overview

Sediments can be collected using either a grab or core sampler. Core samplers are tube-like devices that penetrate the sediment by gravity (free-fall), vibration, hydraulic pressure (water or oil) or by hand (scuba divers). Sediment cores are taken to determine recent and/or historical sediment physicochemical conditions in depositional aquatic environments. The best time to collect bottom sediments from flowing water bodies is during ice-free low flow periods when depositional zones can be easily identified and sampled.

#### Sources

Alberta Environment (2006 a), Environment Canada (1999), Newfoundland and Labrador Environment and Conservation (1999)

#### At a glance

##### Core sampling

*typical  
gravity core  
sampler*

This procedure is specific to gravity corers that are released at the water surface, allowed to free fall and penetrate the sediment under the samplers own weight. A typical gravity core sampler is a length of cylindrical pipe with a weighted head. A liner that is usually made of plastic is inserted to hold the sample. The type of liner appropriate for sampling depends on the sediment variables to be analyzed. At the bottom end of the sampler is a metal core cutter that facilitates sediment penetration (nose piece), and a core catcher to retain the sediment in the liner. At the top end of the sampler is a ball-valve or piston that retains sediment in the liner when the sampler is retrieved from the sediment.

**1** Place a clean liner in the corer or each of the four barrels of the corer, depending on the type of corer being used. Push the liner in until the o-ring fits snugly. The liner should protrude 2 to 5 cm at the bottom.

**2** Set the stoppers in the open position.

**3** Lower the corer over the side of the boat (ensure that the rope is securely attached to the corer and the boat). Lower the corer slowly to minimize the creation of shock waves at the front of the sampler that may disturb and re-suspend fine sediments. Let the corer slowly sink straight into the sediment.

**4** Release the messenger.

**5** Raise the corer after the messenger releases the stoppers. Just before the bottom of the corer breaks the water surface, have a second person reach under and quickly cap the cores with the insert liners. Raise the unit into the boat, keeping it in the upright

position.

**6** Remove each liner from the bottom of the corer. Be careful not to spill any of the enclosed water and then cap the top of each core tube and place in holder.

**7** Taking one core at a time, remove the bottom cap and quickly replace it with the core extruder. Keep constant pressure on the top cap when doing this to help form a vacuum.

**8** Core samples are acceptable if the core was inserted vertically into the sediment, adequate depth was sampled, and there was no sediment loss.

*record  
information*

**9** Photographs, field notes, and measurements should be recorded during sediment core collection. The core should be photographed twice with a digital camera; once in ambient light and once using a fill-in flash. The core sample should occupy a minimum of 70% of the image and a label and a scale (ruler) should be included in the view. Additional photographs should be taken if any anomalies or artifacts are encountered.

**10** Record the total core depth, vertical profile/structure (i.e., depth and description of distinct layers), type of material (soil type, colour, moisture condition, density, and grain size), biological structure (e.g. shells, large tubes, biota, macrophytes), debris (e.g., wood chips, plant or other fibres), obvious signs of anoxia (e.g., black layers), degree of sample disturbance, obvious odour or oily sheen, and any other unusual properties.

**11** Record target and actual sampling location (GPS), date and time of sample collection, overlying water depth (m), ambient weather conditions, core penetration depth, sampling personnel, and any deviations from the field sampling procedure.

*cutting core  
into sections*

**12** To cut the core into sections, remove the top cap from the tube and siphon off excess water. Carefully push the sediment core to the top of the core tube, expelling any remaining excess water. Set the core slicer on the top of the sediment tube. Push the sediment into the core slicer and cut off the required amount of sample, usually the upper 4-6 cm (can be 2 to 10 cm of the upper layer). Place the sample in a labeled sample container. Place each sample container in two Ziploc-type plastic bags (double-bag) in case of leakage.

**13** Rinse the tubes and corer with lake water before collecting new samples or decontaminate the equipment between sites.

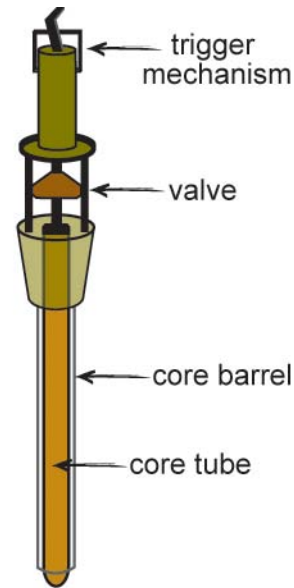

Figure 10. Kajak-Brinkhurst core sampler (British Columbia MWLAP (2003))

### Sediment grab sampling

This procedure is specifically used to collect surficial sediment samples and is conducted when the quality of recently deposited sediments is of interest and relatively large volumes of sediment is required. Grab samples can be easily taken in depositional shallow sediments or in relatively coarse sediments, where core samples cannot be obtained. Each device consists of a set of mechanical jaws, which shut when lowered into the sediment. The three commonly used samplers are Ekman (used for soft fine-grained sediments), Peterson (used for hard bottom material) and Ponar (used for fine-grained to more coarse sediments) grab samplers.

- 1** Label the sample containers with site identification, sample type, sampling method, sampler ID, and the date of collection. Record the following site/sampling information in the field sheet/book during the sampling process: target and actual sampling location (GPS, date and time of sample collection, overlying water depth (m); weather conditions, sampling personnel, macrophyte growth and any deviations from the field sampling procedure.
- 2** Ensure that the dredge jaws open and close properly.
- 3** Lock the dredge jaws in the open position and lower in a controlled fashion to the lake/river bottom. Do not allow the sampler to “free fall”. The sampler should be in contact with the substrate or positioned just above it.
- 4** Drop the messenger (if applicable) and slowly raise the

sampler off the bottom to prevent loss of fine sediment and then raise the dredge to the water surface.

**5** The sample is deemed acceptable if the desired depth of penetration has been achieved; and the sampler has completely closed and was not inserted on an angle or tilted upon retrieval. If the sample does not meet these criteria the sample should be taken again close to the original sampling location. The rejected sample should be discarded in such a way that it will not affect subsequent sampling efforts. The actual achievable penetration depth depends on the nature of the sediment and the sampling device used. A minimum penetration depth of 6 to 8 cm is recommended for surficial sediment samples but the preferred depth is 10 to 15 cm. These depths ensure minimal disturbance to the upper 2 to 5 cm of sediment that will be removed from the grab sample and submitted for physicochemical analysis.

**6** Record the following sediment measurements/observations (where applicable): grab penetration depth, depth sub-sampled, type of material (sediment type, colour, moisture condition, density, and grain size), biological structure (e.g. shells, large tubes, biota, macrophytes), debris (e.g., wood chips, plant or other fibres, obvious signs of anoxia (e.g., black layers), degree of sample disturbance, obvious odour or oily sheen, and other unusual properties.

**7** Siphon off any water on the surface of the grab sample with a syringe, if the water is cloudy allow it to settle first (use a new syringe for every site). Remove the upper 2 to 5 cm of sediment (according to study design) with a stainless steel or Teflon implement and transfer to a stainless steel/plastic tray/bowl. Avoid sediment at the edges of the grab sample (touching the grab sampler).

**8** If more sediment is needed to obtain the necessary volume for analysis, continue collecting grab samples from the same site in undisturbed sediment. The composite sample tray/bowl should be covered while grab samples are being collected. The number of grab samples collected to form a composite sample should be noted.

**9** Wash the dredge off in the site water. Rinse bucket and ladles before and after each site in the water body.

**10** Once sufficient sediment is collected, stir (homogenize) the composite sample for 30 seconds, then transfer into the appropriate pre-labeled containers with a stainless steel or Teflon implement.

*preparing  
the sample*

**Other  
sources**

B. C. WLAP (2003), Environment Canada 2006 (a)





Photo 14. Transferring sediment samples to containers  
(Courtesy: Darcy McDonald Alberta Environment)

## 7.2 PROTOCOL FOR AIRLIFT SEDIMENT MONITORING

<b>Overview</b>		This procedure is used to sample sediments present in deep, moderately slow rivers.
<b>Sources</b>		Alberta Environment (2006 a)
<b>Special safety concerns</b>	<i>use caution with compressed air</i>	Be careful with storage and handling of the compressed air gas tanks. They are highly pressurized and the valve, if damaged, can cause the tank to turn into a projectile. When transporting the tanks by truck or boat, immobilize them in an upright position. Pressurized tanks cannot be transported by helicopter.
<b>At a glance</b>		<ol style="list-style-type: none"><li><b>1</b> Remove the protective cap from one tank just before setting up.</li><li><b>2</b> Carefully attach the regulator to the tank and be careful not to over tighten as the brass threads will easily strip.</li><li><b>3</b> Attach hoses and the air lift sampler to the tank.</li><li><b>4</b> With the regulator closed, carefully open the main tank valve fully and then turn the valve back one full turn.</li><li><b>5</b> Slowly open the regulator until the pressure in the second stage reaches 20-45 psi (140 to 310 kPa).</li><li><b>6</b> Place the inlet of the sampler on the substrate to create a good seal by moving it around until it feels stable and set into the substrate.</li><li><b>7</b> Deliver short pulses of compressed gas to the sampler.</li><li><b>8</b> Collect the thickest slurry in clean buckets (pre-filter it through an 80 µm mesh held under the sampler outlet to limit particle size).</li><li><b>9</b> Collect five to six buckets in total and move the sampler frequently.</li><li><b>10</b> Clearly label the site on the buckets and ensure that their lids are tightly sealed.</li><li><b>11</b> When finished sampling turn off the main valve on the tank, bleed pressure out of the line and unhook the hoses. Carefully remove the regulator and replace the protective cap on the tank.</li><li><b>12</b> Record number and size of buckets collected, exact sampling location, flow conditions, turbidity of the river, amount and a description of the sediment, abundance of attached algae and macrophytes, as well as date and time.</li><li><b>13</b> Upon return to the laboratory, let the buckets containing the sediment stand for 20 to 24 hours.</li><li><b>14</b> Siphon off the supernatant, saving this in clean jar(s) as it may be analyzed for the same parameters as the sediment.</li><li><b>15</b> Put the remaining sediment in clean glass jars.</li><li><b>16</b> Let the jars sit for 24 hours in a refrigerator. Then remove the supernatant from the top of the jar and save with the previously collected supernatant.</li></ol>

- 17** Collect a minimum of one 500 mL jar of sediment.
- 18** Clearly label the jar with site and date.
- 19** Freeze the sample.



Photo 15. Air lift sampler (Courtesy: Darcy McDonald, Alberta Environment and from Alberta Environment (2006))

## 7.3 PROTOCOL FOR SAMPLING SUSPENDED SEDIMENTS

### Overview

Suspended sediments should not be construed as being suspended solids samples since the former are measured usually by taking a set volume from one depth/location and passing the volume through a filter to obtain a weight of solids. In contrast, suspended sediments are collected using samplers that allow the sediment and water to enter the sampler at the same velocity as the stream water. The US Geological Survey (USGS) has designed numerous types of samplers for different applications. The reader is advised to review USGS (2005) to select the sampler appropriate for the conditions that may be encountered.

### Sources

Federal Interagency Sedimentation Project (1965), Environment Canada (1999)

### At a glance

#### Manual collection

- 1** Use a clean bottle for each separate sediment sample.
- 2** Use one suspended sediment sample for each vertical point selected in a stream cross-section.
- 3** Orient the intake nozzle upstream directly into the current.
- 4** Hold in a horizontal position while the sediment sampler is lowered into the stream.
- 5** Avoid submerged obstructions immediately upstream.
- 6** Lower the sampler at a uniform rate from the water surface to the bottom of the stream, then immediately reverse and raise it to the water surface at a uniform but not necessarily equal rate to that used to lower the sampler.
- 7** Immediately remove the bottle, cap it, and mark details on it: sample site, date and time of collection, location in cross section, and total depth at sample location.
- 8** Discard the sample if the bottle becomes entirely full.
- 9** Determine from the laboratory the actual volume sample requirements as this may involve more than one composite sample to be collected from each location.

#### Centrifuge collection

- 1** Ensure that the centrifuge top assembly is constructed of stainless steel (solvent washable) if collection of both suspended sediment and centrifugate is planned. Use a standard cast iron top assembly if centrifugate collection is not anticipated.
- 2** *prior to initial setup* Prior to initial setup, wash the centrifuge bowl(s), internal discs, and hold-down nut(s) with soap and water, rinse again with water, then follow with a final rinse with de-ionized water. Rinse the bowl, hold-down nut, T-wrench, top assembly, and intake lines with acetone, then hexane. Install the solid disc (i.e. the one with no holes) on the bottom of the disc pile. Wrap

these parts in fired aluminum foil for transfer to the sampling location (to fire aluminum foil, remove foil from the cardboard roll, place in muffle furnace at 400° C for 3-6 hours).

**3** Install the centrifuge bowl on the centrifuge spindle, screw in the two bowl stops and tighten the cast retaining ring using the large bowl ring and the rubber hammer (counter-clockwise to tighten) once at the sampling location. Tighten the retaining ring until the marks on the ring and bowl match. Tighten the upper ring holding the light top flange hand-tight. Use clean disposable polyethylene gloves while handling the centrifuge bowl. Unscrew the bowl stops after the bowl flanges have been attached and ensure that the brake is not engaged by testing that the bowl spins freely. Replace the top assembly and screw down the assembly stops.

**4** Attach the sheathed Teflon intake line to the submersible pump, and secure the pump in the position and location desired (position the intake facing upstream). Pump water through the lines for approximately two minutes prior to attaching to the centrifuge top assembly.

*start  
centrifuge  
before pump*

**5** Start the centrifuge with the submersible pump off. Once operational speed has been reached (1-2 minutes), re-start the submersible pump, and adjust the intake valve on the top of the centrifuge for a flow of 4 litres/minute. Use the graduated cylinder and a stopwatch to measure the flow. Check the flow rate a number of times during the initial 15 minutes of operation, and then approximately hourly thereafter. Record the time that sample collection started, the flow rate, and any other pertinent variables in a field notebook.

**6** Use Teflon tubing, preferably flex-tubing, to attach to the centrifuge outlet if centrifugate is to be collected. The generator (at least 3500 watt, preferably 5000 watt) should be situated as far from the centrifuge as practical (and downwind) to reduce the chance of sample contamination from generator exhaust.

**7** Collect samples of raw sample water and centrifugate periodically to check on centrifuge recovery efficiency and to allow subsequent calculation of sediment and contaminant loading.

**8** At shutdown, first stop the submersible pump (noting the time in the field notebook) and then shut down the centrifuge. Allow the centrifuge bowl to come to a complete stop before opening the top assembly. The bowl break should only be used once the bowl has nearly come to a stop.

**9** Screw in the two bowl stops, and loosen the large cast flange (clockwise to loosen). Loosen the bowl stops and remove the bowl from the spindle. Pour out (gently and slowly) any residual water in the bowl. Cover the bowl opening with fired aluminum foil until the sample is removed.

**10** Use solvent-washed stainless steel spatulas and/or knives to

transfer sediment from the centrifuge bowl to pre-cleaned, tare weight determined and pre-labeled sample containers of the appropriate type. Once the sample has been transferred, weigh and calculate sample wet weight. Record the wet weight on the sample container and in the field notebook.

**11** Wash and rinse the centrifuge bowl as soon as possible before sediments have a chance to dry on the bowl and discs, which makes the task much more difficult.



Photo 16. Manual suspended sediment sampler on sampling rod

## 7.4 PROTOCOL FOR SEDIMENT OXYGEN DEMAND MONITORING

### Overview

Sediment oxygen demand (SOD) is a measure of the oxygen consumed by biochemical decomposition of organic matter in stream or lake deposits. SOD over a defined time period can be measured in-situ using a chamber method, or sediment cores can be taken for subsequent incubation and SOD measurement in a controlled environment.

### Sources

Alberta Environment (2006 a)

### At a glance

This method refers to the measurement of SOD using an *in-situ* chamber. However, it should be noted that this may not be applicable to all sites because of issues such as vandalism or accessibility.

### Filling the chambers

**1** Choose representative substratum for the site. Substratum composition ideally should be cobble and gravel interspersed with fines. Substrate should not be so large as to not fit inside the chamber. Chambers should be placed in areas of flowing water. Ideal working depth (from ice surface to substrate) is between 50-70 cm, but no greater than 90 cm. Ensure that sufficient distance between bottom of ice and top of velocity vanes exists to allow vanes to spin freely.

**2** Check that each chamber has all stoppers attached to the lid (use light-duty chain and epoxy cement) and that rubber and foam gaskets are secured and in good condition on the chamber. Foam gaskets on ALL chambers should be completely changed before undertaking any new work.

**3** Ensure that the lid fits snugly on the chamber (each chamber has the same exclusive number for the lid and base) and that the snap-down clips operate correctly.

**4** Check that the water vanes rotate freely and the Teflon washers are in good condition

**5** A total of four chambers will be filled with substratum; and one “control” chamber to be filled with river water.

**6** Choose representative substratum for the sites to be used in the study area.

**7** Fill chambers with ambient water to about ¼ of its depth. Fill ¼ of the chamber with finer material such as gravel and sand to form a base on which the larger cobble can rest on.

**8** Using a shovel, carefully remove undisturbed cobble and gravel from the substrate and place atop the sand/gravel base in the chamber. Arrange rocks (epilithic cover must face up) such that they are representative of substratum conditions at the sample site.

**9** Equal amounts and type of substratum should be placed in

each chamber. Compare with other chambers.

**10** The chambers are usually filled between 1/3 and 1/2 of the chamber depth to leave room for the water vane unit on the inside of the chamber.

**11** Place the chamber, without the lid, very carefully into the water and allow it to fill very gradually to reduce disturbance to the substratum in the chamber.

**12** Position the chamber on the stream bottom in a level fashion.

**13** Leave the chamber in position until the sediment in the chamber has settled or flushed. This is important since the suspended material in the water column may increase oxygen demand in the chamber.

### Closing the chambers

**1** Ensure that the rubber and foam gaskets and the water sample tube are free from ice or sediment.

**2** Remove the stoppers from the portholes in the lid and place the lid gently onto the chamber making sure that no bubbles are trapped between the flange and the lid.

**3** In deeper depths, another chamber (that has been turned over onto the substrate) can be used as a platform to elevate the chamber to a suitable working depth.

**4** Check that the foam gasket on the lid is snugly fitted onto the chamber base.

**5** Ensure that the four snap-down clips on the chamber lid have been extended equally (clockwise to tighten, counter-clockwise to loosen) for easier clamping and to prevent warping of the lid.

*diagonally  
opposite  
clips*

**6** It is very IMPORTANT to close two diagonally opposite clips on the lid simultaneously, and repeat with remaining clips. It may be necessary to adjust the clips so that they snap down briskly onto the base, giving a secure fit.

*time of lid  
closure*

**7** Making sure that the chain is not wrapped around the base of the vane, replace the stoppers securely in the portholes. Having some slack in the chain will allow for some give if the chain is struck by ice or debris. IMPORTANT: Record time of lid closure for each chamber to the nearest minute on field sheet.

**8** Depending on river velocity and site location, it may be necessary to anchor the chambers. This can be accomplished by using rope secured to one or more t-posts pounded into the ice surface (in winter conditions) and tied to the chamber handles.

**9** In higher velocity locations, rocks may be piled up against the base of the chambers for extra stability.

**10** Measure river ambient DO concentrations.

### Obtaining the sample

**1** Take note of any unusual conditions: stopper not in porthole, retaining clip open, vane performance (spin or no spin), chamber tipped over, etc., and record on SOD field sheet.



**2** Rotate water vane of all the chambers very slowly to achieve complete mixing of water.

**3** Remove from river and record chamber number, date, and time.

**4** Open the smallest stopper, gently rotating the vane, place Tygon tubing over the water sample tube and carefully siphon water into the Winkler bottle. Note: Sample should be discarded if air bubble or ice is present in Winkler bottle. Replace Tygon tubing if freezing occurs.

**5** Preserve with Winkler chemicals.

**6** After water samples for DO measurement have been taken, remove lid of the chamber.

*calculating  
chamber  
volume*

**7** In order to measure the volume of the chamber, place the depth-profile measuring device over the opening of the chamber and secure using the 3 alignment pins. Place the depth-profile measuring rod (pre-marked in 0.5 cm increments) through one of the holes in the Plexiglas plates until the rod touches the substratum. Record the depth as indicated on the rod and subtract 0.5 cm (width of the Plexiglas as it sits above the chamber flange) from the total. This measurement will give the distance from the top of the rock to the underside of the Plexiglas. Record on field sheet.

**8** Record dissolved oxygen of the water within the chamber.



Photo 17. SOD chamber  
(Alberta Environment (2006a))

## 8.0 PROTOCOLS FOR SAMPLING FISH

### 8.1 PREVENTION OF SPREAD OF AQUATIC INVASIVE SPECIES

#### Overview

Ensure specific protocols are followed to prevent the spread of aquatic invasive species when sampling for fish. Ensure specific nets and gear are used for each water body, the following cleaning protocols should be used after retrieving or before setting nets and related gear into a new water body.

#### Sources

Manitoba Water Stewardship (2010)

#### At a glance

**1** Clean and inspect all nets and gear by removing all plants, animals and mud at the source.

**2** Rinse nets and gear using high pressure, extremely hot tap water – preferably 50°C (120°F), or dry nets and gear for at least 5 days in the hot sun (if rinsing is not available).

**3** Alternatively, freeze all nets and gear for two or more days, or soak nets and all equipment in a 1) table salt water solution (230 g (2/3 cup) of salt to 1 L (1 gallon) water) for 24 hours or 2) undiluted white vinegar for 20 minutes, or 3) diluted household bleach solution (> 5% sodium hypochlorite at a concentration of 100 ml (~3 ounces) of bleach to 20 L (~5 gallons) of water) for 60 minutes.

### 8.2 PROTOCOLS FOR FISH COLLECTION AND PROCESSING TISSUES

#### Overview

The fish collecting and processing protocols outlined here are designed primarily for the purpose of analyzing tissues for levels of bio-accumulated substances. Since fish are high on the aquatic food chain, analyses of their tissues may provide valuable toxicological information about substances that are difficult to measure in ambient waters (such as mercury). The various collection techniques discussed here are partially selective in terms of the species and size classes. Therefore, the particular method to be used will depend on the purpose of the study and should be outlined in the project design.

#### Sources

British Columbia MWLAP (2003), Ministère de l'Environnement, Gouvernement du Québec. (2004), Newfoundland and Labrador Environment and Conservation (1999)

## At a glance

**1** Always record date and time of each net set. It is recommended that depth and bottom type be recorded as well.

**2** For collecting fish samples, permits are necessary from the appropriate agencies.

**3** For each species captured at a given site, the object should be to obtain a certain number of specimens (e.g., five for each of small, medium and large). The study design will indicate whether whole fish, muscle tissue, with and without skin, or organs should be collected.

## 8.3 PROTOCOL FOR SAMPLING FISH WITH GILL NETS

### Overview

Gill nets are constructed of fine monofilament line suspended between a buoyant ‘float line’ and a non-buoyant ‘lead line’. Nets may be all one mesh size or may be composed of different mesh sizes by joining a series of panels. Panels are generally 15 metres long. The mesh size of a panel is measured by pulling two opposing knots of a mesh-hole tight and measuring the distance. Mesh sizes generally range from 2.5 to 12.5 cm. The size of the mesh chosen will determine the size of the fish that will be caught. The ends of the net are equipped with a bridle, tether lines, anchors and buoys. Gill nets can either be set with an anchoring point on shore or with both ends anchored in open water. There are two types of gill nets, floating gill net - positive buoyancy for capturing surface-dwelling species, and sinking gill net - negative buoyancy for capturing bottom-dwelling species.

### Sources

British Columbia MWLAP (2003), Ministère de l’Environnement, Gouvernement du Québec. (2004), Newfoundland and Labrador Environment and Conservation (1999)

## At a glance

### *net location*

**1** Select a location where there is both an ideal shore line anchoring point (e.g., a tree, a large rock, a dock etc.) and suitable near shore depth (so the net will not bunch on the bottom). Avoid setting the net near obstacles such as sunken stumps or logs that can entangle and rip nets.

**2** Tie one end of the net to the shore anchor point with a tether line. Load the remainder of the net neatly into the boat.

**3** One person then slowly rows in the direction that the net is intended to be set while the other person gently feeds the net out. (Hint: If the boat has protuberances, rivets, or sharp edges that will snag the net during deployment, it is advisable to cover

these with a sheet of poly film.)

*be aware of  
boaters,  
swimmers,  
boating  
lanes*

*retrieving  
net and  
removing  
fish*

**4** Once the net is at full extension, the anchor is lowered and the buoy deployed. Attach labeled buoys to the float line at intervals of about 5 meters to warn boaters. Do not set a net near a swimming beach during swimming season, or leave a net unattended near boating lanes. Note: Ensure that the buoy is well flagged.

**5** While kneeling, grab the float line and pull the boat along the net to check for fish (if the boat is equipped with a motor, raise it to avoid entanglement with the net). Collect any fish encountered. If enough fish have been caught, reverse your path and retrieve the net. (Hint: If there is any wind, it is advisable to retrieve the net against the wind to prevent the boat from drifting over and entangling the net.) When retrieving the net there is the option of hauling the net in and then removing the catch or, removing the catch first. Removing the fish before the net is in the boat poses fewer entanglement problems.

**6** Place captured fish in an ice-filled cooler. Label cooler for the site if there is more than one capture site.

**7** Return to shore and process the fish.

#### Protocol for gill net – open water

**1** Load the net neatly in the bow of the boat and proceed to the deployment site (established in the project design). Avoid sunken stumps or logs that can entangle and rip nets.

**2** Anchor one end of the net securely. The person in the bow is responsible for deploying the net while the person in the stern controls the boat (reverse in the direction the net is to be set). (Hint: try to set the net with the wind to prevent the boat from drifting over and entangling the net. Alternatively, you may set against the wind in reverse while under power.)

*be aware of  
boaters,  
swimmers,  
boating  
lanes*

*retrieving  
net and  
removing  
fish*

**3** Gently feed the net out and set the other anchor when the float line is taut. Attach labeled buoys to the float line at intervals of about 5 meters to warn boaters. Do not set a net near a swimming beach during swimming season, or leave a net unattended near boating lanes. Note: Both buoys should be well flagged and labeled.

**4** While kneeling, grab the float line and pull the boat along the net to check for fish (if the boat is equipped with a motor, raise it to avoid entanglement with the net). Collect any fish encountered. If enough fish have been caught, reverse your path and retrieve the net. If there is any wind, it is advisable to retrieve the net against the wind to prevent the boat from drifting over and entangling the net. When retrieving the net (after having been set for an appropriate period of time), there is the option of hauling the net in and then removing the catch or removing the catch first. Removing the fish before the net is in the boat poses fewer entanglement problems.

**5** Place captured fish in an ice-filled cooler. Label cooler for

the site if there is more than one capture site.  
**6** Return to shore and process the fish.

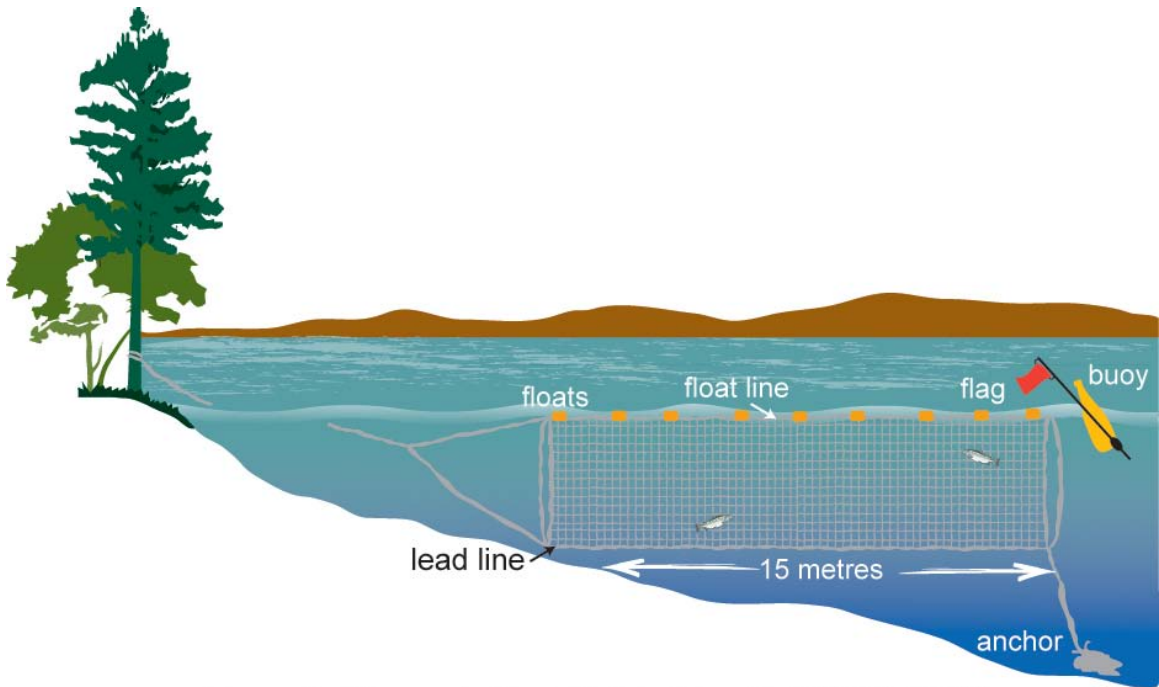

Figure 11. Shore-set gill net (British Columbia MWLAP (2003))

## 8.4 PROTOCOL FOR SAMPLING FISH WITH BEACH SEINES

### Overview

A seine is a panel of netting pulled by bridles at each end. For many smaller seines, the bridle is attached to pulling poles or 'brails'. The upper line of the seine is equipped with floats and the lower with weights. Beach seines are effective only over shorelines and river bottoms that are free of obstacles such as logs, stumps, or large boulders.

### Sources

British Columbia MWLAP (2003)

### At a glance

**1** For **small seines where wading is employed**, one person holds a brail securely against the bottom in ankle deep water while the second person wades directly out with the other brail. The first person remains stationary while the second pulls the seine to full extension and sweeps around pulling the net back in toward shore (all the while ensuring that the weighted line remains against the bottom). Both people then pull the net up on shore where the fish are collected and processed.

**2** For large seines where the beach seine is deployed from a boat, attach a length of rope to each bridle (the length will be the distance off shore from which the seine net will be pulled).

**3** Tie an anchor to one of the ropes and brace the anchor on shore. Load the net into the bow of the boat.

**4** The operator of the boat then reverses slowly directly away from shore while the person in the bow feeds the rope out. Once the end of the rope is reached, the boat operator turns 90° and proceeds (in reverse) parallel to the beach while the person in the bow of the boat feeds out the net.

**5** Once the end of the net is reached, the boat operator turns back towards shore while the person in the bow feeds out the rope. The net is retrieved by pulling from both ends at the same rate (this ensures that the net is not pulled in at an oblique angle).

*retrieving  
the net* **6** When the net is about 10 m from the beach, the two people then approach one another as they continue to haul it up on the beach where the fish are collected and processed.

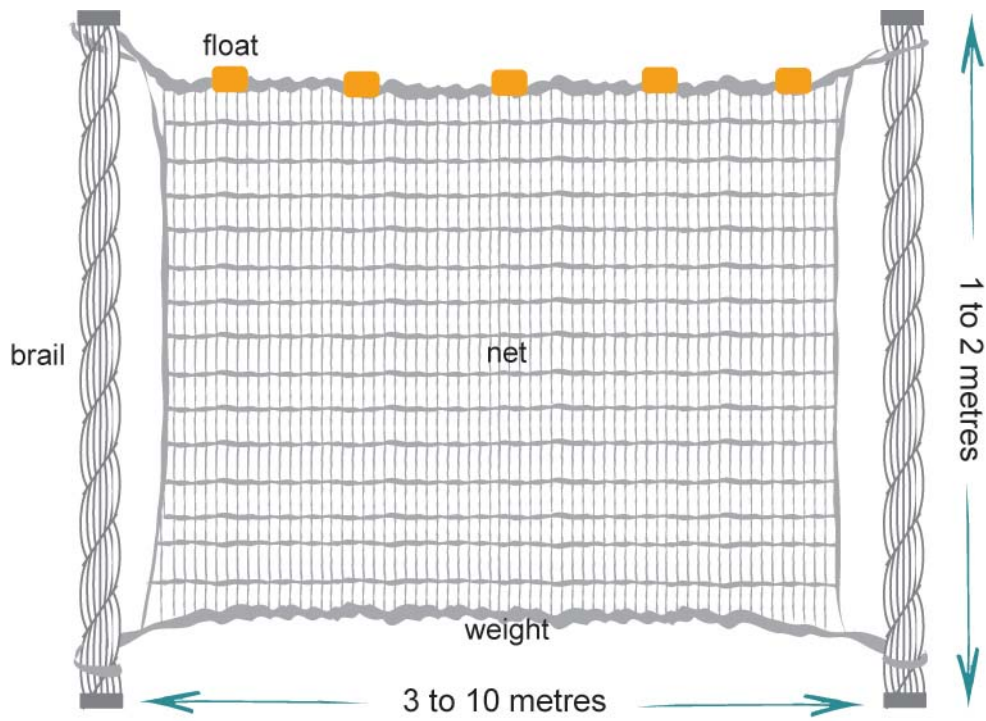

Figure 12. Seine net (British Columbia MWLAP (2003)).

## 8.5 PROTOCOL FOR SAMPLING FISH WITH SET LINES

### Overview

A set line is a heavy line anchored at each end (one anchor having the flag line). It has regularly spaced leaders with hooks. Setlines can be used in situations where the use of nets is not suitable, for example very deep or fast flowing waters. Bait each hook and load the line carefully into the bow of the boat. Carefully lower the end of the line (anchor without a buoy or marker line).

### Sources

British Columbia MWLAP (2003)

### At a glance

**1** The boat operator then slowly reverses in the direction the line is to be set while the person in the bow carefully feeds out the line (**use extreme caution with the hooks**). **Never wrap a line around your wrist, arm, or leg due to danger of the line snagging.**

**2** Once the end of the line is reached (the other anchor is encountered), the anchor is lowered using the flag (buoy) line and the boat operator reverses slowly to ensure that the line is taut.

**3** To retrieve the line, haul up the flag line until the first hook is reached and then slowly move in the direction that the line is set as the remaining hooks are hauled into the boat.

**4** Return to shore and process the fish.



## 8.6 PROTOCOL FOR ELECTRO-FISHING SAMPLING

### Overview

Electro-fishing is potentially dangerous; consequently, all staff undertaking such work should be certified before using this technique. Electro-fishing is an ideal tool in smaller streams where the bottom is uneven or where there are obstructions that make conventional collecting techniques difficult. It can be used either to stun the fish so that they can be collected with a dip net, or to scare the fish ahead of the electrical field into a net (seine) that spans the width of the stream.

### Sources

British Columbia MWLAP (2003)

### Special safety concerns At a glance

*certification  
needed*

All members of the sampling team must be certified through an Electro-fishing Course.

**1** Follow the manufacturer's directions for storage, transport, operation, and maintenance of the specific shocking device available to you.

**2** Set a net the width of the creek downstream from where you begin electro-fishing.

**3** Work toward the net until a sufficient number of fish have been trapped.

**4** Collect and process as per *Protocol for processing fish tissues*. If the fish are too small to process in the field, they may have to be submitted as whole specimens (outlined in the project design).

**5** Note effort required to collect fish (as an index of catch per unit effort) and the instrument settings for the stream conditions.

**6** For the recorded notes, approximate fishing area (i.e., length and width of stream).

*be aware of  
hold times*

**7** The day's sampling schedule must be planned to ensure that the samples arrive well before the end of business hours so they can be shipped the same day. Since some variables have very limited hold times, every effort must be made to avoid delays in shipping.

## 8.7 PROTOCOL FOR FISH COLLECTION WITH A FYKE NET

### Overview

This protocol indicates how a Fyke net is set.

### Sources

Newfoundland and Labrador Environment and Conservation (1999)

### At a glance

Fyke nets consist of an internal cone that directs fish into a trap box. Wings and leaders can be used to direct fish into the box.

- avoid obstacles when setting net*
- 1** Select a location where there is both an ideal shore line anchoring point (e.g., a tree, a large rock, a dock, etc.) and suitable near shore depth (so the net will not bunch on the bottom). Avoid setting the net near obstacles such as sunken stumps or logs that can entangle and rip nets.
  - 2** Tie an anchor to one of the ropes and brace the anchor on shore.
  - 3** Attach labeled buoys to the float line to warn boaters. Do not set a net near a swimming beach during swimming season, or leave a net unattended near boating lanes. Note: Ensure that the buoy is well flagged.
  - 4** When retrieving the net (after having been set for an appropriate period of time), there is the option of hauling the net in and then removing the catch or removing the catch first. Removing the fish before the net is in the boat poses fewer entanglement problems.
  - 5** Place captured fish in an ice-filled cooler. Label cooler for the site if there is more than one capture site.

## 8.8 PROTOCOL FOR MINNOW TRAPS

**Overview** This protocol indicates steps to be undertaken to collect fish using a minnow trap.

**Sources** Newfoundland and Labrador Environment and Conservation (1999)

**At a glance** *trap live fish* Minnow traps are net or wire enclosures used to trap live fish. The fish swim through a large funnel-shaped opening near the outside of the trap to the narrower opening close to the centre of the trap. Once inside, it is difficult for the fish to locate the opening and escape.

**1** Select a location where there is both an ideal shore line anchoring point (e.g., a tree, a large rock, a dock, etc.) and suitable near shore depth (so the net will not bunch on the bottom). Avoid setting the trap near obstacles such as sunken stumps or logs that can entangle and rip traps.

**2** Tie an anchor to one of the ropes and brace the anchor on shore.

**3** Attach labeled buoys to the minnow trap to warn boaters. Do not set a trap near a swimming beach during swimming season or leave a trap unattended near boating lanes. Note: Ensure that the buoy is well flagged.

**4** When retrieving the net (after having been set for an appropriate period of time), there is the option of hauling the net in and then removing the catch or removing the catch first. Removing the fish before the net is in the boat poses fewer entanglement problems.

**5** Place captured fish in an ice-filled cooler. Label cooler for the site if there is more than one capture site.

## 8.9 PROTOCOL FOR PROCESSING FISH TISSUES

### Overview

This protocol indicates steps to be undertaken to prepare fish tissue samples for metals or trace organic analyses.

### Sources

British Columbia MWLAP (2003)

### At a glance

#### Trace metal analyses

- 1** Each specimen should be identified, weighed, measured, and scale samples taken for aging before dissection. Gender should be determined after dissection, and maturity should be commented on if possible (i.e., degree of egg or sperm development).
- 2** Wipe specimen clean of mucous and foreign matter with a 4% nitric acid/de-ionized water solution prior to dissection. Dissect specimens on a cleaned glass or plastic surface only.
- 3** When removing a block of tissue from the specimen, the cutting instrument (plastic or stainless steel knife) should be wiped clean after each incision using a paper towel soaked with de-ionized water. Use a new paper towel for each specimen dissected. The preferred location on the fish for a sample of muscle tissue is the upper part of the side behind the dorsal fin. Care should be taken not to cut into the digestive tract during dissection. If the target fish are small, composite tissue samples may be required (this will be identified in the project design).
- 4** Remove a minimum of 100 g of muscle tissue and place in a pre-labeled tissue cup (acid washed, leak-proof plastic containers available from the issuing laboratory). Remove the liver and place in a pre-labeled tissue cup. Muscle tissue samples should be free of skin and bones. Liver samples must exclude the gall bladder.
- 5** Immediately place each tissue cup in a cooler containing ice packs.
- 7** Wipe the glass or plastic dissecting board clean with the 4% nitric acid/de-ionized water solution before proceeding to the next specimen. The acid should be certified pure and a QC check conducted of the working solution for contamination. An alternative is to use solvent washed aluminum foil as a disposable clean surface (replace after each specimen).

#### Trace organic analyses

- 1** Each specimen should be identified, weighed, measured, and scale samples taken for aging before dissection. Gender should be determined after dissection, and maturity should be commented on if possible (i.e., degree of egg or sperm development).
- 2** Wipe specimen clean of mucous and foreign matter with de-ionized water (stored in a glass container) prior to dissection.

Dissect specimens on a glass or stainless steel surface only. At no time should the sample come into contact with plastic.

*dissecting*

**3** When removing a block of tissue from the specimen, the pre-cleaned (solvent washed, heat treated) cutting instrument should be wiped clean after each incision using a paper towel soaked with de-ionized water. Use a new paper towel for each specimen dissected. Care should be taken not to cut into the digestive tract during dissection.

**4** Remove a minimum of 50 g of muscle tissue and place in a pre-labeled glass container (acetone washed, heat treated at 400°C and available from the issuing laboratory). Remove the liver and place in a pre-labeled glass container. Muscle tissue samples should be free of skin and bones. Liver samples must exclude the gall bladder.

**5** Immediately place each tissue cup into a re-sealable bag (e.g. Ziploc) and then in a cooler with ice packs (or dry ice if possible if sample is to be analyzed for volatile or semi-volatile organics).

**6** Wipe the dissecting board clean with de-ionized water before proceeding to the next specimen.

## 8.10 PROTOCOL FOR SAMPLING PARASITES IN FISH

### Overview

All organisms to be examined for any particular survey should come from the same habitat and should not be pooled across habitats. Twenty to 30 organisms are required for a general parasite survey from the average age or size class for the population. For best results, analysis of data by age, size, sex, or season requires 30 host animals in each class. Samples of 25-30 fish permit detection of parasites if the prevalence is 10% or more. Detection of rare parasites requires greater sample size. Preferably, host organisms should be examined fresh for parasites or organisms should be frozen as soon as possible after capture.

Hosts fixed in preservative are of little use for parasitological examinations. Fish can be euthanized by pithing if small, a blow on the head if large, by cervical dislocation, or by an overdose of anesthetic such as tricaine methanesulfonate (MS 222). All hosts should be individually bagged to prevent loss of ectoparasites and labeled with collection data (date, sampling site, collector). Host organisms returned to the laboratory alive should be examined within a few hours. Otherwise, parasites with direct life cycles may spread between hosts or increase on infected hosts. Hosts kept in captivity for prolonged periods may lose many parasites. Loss of ectoparasites also may occur with certain methods of capture such as gill-netting. Parasite surveys should be done in spring-early summer and late summer because populations can fluctuate seasonally. If only one survey is scheduled, sample in July.

### Sources

EMAN (Undated b)

### At a glance

- 1** Capture fish using any of the methods outlined in the Manual.
- 2** Record host species, date caught, site sampled, method of collection, name of collector, name of examiner.
- examine* **3** Measure and weigh fish. Rinse external surface; collect rinse and examine with stereomicroscope for ectoparasites. Examine external surface using stereomicroscope.
- rinse* **4** Remove gills, rinse. Examine each gill arch individually and the rinse with stereomicroscope.
- 5** Rinse buccal cavity; examine rinse with stereomicroscope.
- 6** Remove, dissect, and examine eyes (humor, retina, lens) with stereomicroscope.
- 7** Remove otoliths, fins, or scales for aging, if required.
- examine* **8** Remove fins and examine with stereomicroscope.
- organs* **9** Open body cavity ventrally; record sex. Examine cavity and surface of internal organs (heart, liver, spleen, gall bladder,

digestive tract, gonads, kidney, urinary bladder) for parasites. Separate organs into Petri dishes with water.

**10** Separate stomach, pyloric caeca, and intestine. Open longitudinally and examine for parasites with stereomicroscope. For extensive gut contents, rinse into beakers, mix with sodium bicarbonate (1 spoonful per litre) to remove mucus, and allow parasites to settle. Decant and examine residue with stereomicroscope.

**11** Cut organs and tissue (wall of stomach, pyloric caeca, intestine, liver, spleen, kidney, heart and large blood vessels, gonads, gall bladder, urinary bladder, brain) into smaller pieces, compress between glass plates, and examine with stereomicroscope.

**12** Rinse the body cavity and examine rinse with stereomicroscope.

**13** Thin-slice musculature and inspect for parasites.

**14** Record number of parasites of each species and their location in the host on data sheet.

*use hot or warm fixatives*  
**15** Fix all live parasites in hot or warm fixatives to kill them rapidly and at the same time avoid muscular contractions by the parasites, which then distorts their shape when fixed. For living, small monogeneans firmly attached to the gills, freeze a section of tissue with parasite attached overnight in water or 0.7% saline solution. The parasite will detach from the tissue and relax. It can then be thawed, retrieved, and fixed in 10% buffered formalin. Other helminths (cestodes, trematodes, acanthocephalans) should be heat-fixed in 70% ethanol, or relaxed in tap water (if alive) and fixed in 10% buffered. Nematodes should be fixed in hot (not boiling) 70% ethanol with 5% glycerol. Berland's fluid may also be used for nematodes and platyhelminths. Encysted parasites can be removed from their cysts by careful dissection with fine needles or forceps or gentle pressure with a coverslip on a slide. If these techniques fail, place the cyst in 0.5% trypsin and heat to 37-40°C. Encysted acanthocephalans found in the viscera can be placed in tap or distilled water in the refrigerator overnight to stimulate eversion of the proboscis. Fix in 70% ethanol, 10% buffered formalin or AFA.

*careful dissection*

**16** Anesthetize arthropods in carbon dioxide bubbled through water, and then fix them in 70% ethanol.

**17** Narcotize leeches to avoid contracting when fixed. Carbon dioxide bubbled through water can be used to anesthetize leeches after which they can be fixed in 10% buffered formalin.

**18** Place each parasite species or type from each organ in a separate vial and label with host species and host number, geographic locality, date of capture, location in host, fixative used, and date of examination. Formalin- or AFA-fixed specimens should be transferred to 70% ethanol after 1-7 days,

and definitely for a few days prior to staining.

**19** Stain monogeneans, trematodes, cestodes, and acanthocephalans in acetocarmine and mount them on permanent slides. Acanthocephalans should be pricked in a few places with a fine needle prior to staining.

**20** Clear nematodes by evaporation in glycerol in 70% ethanol, letting the alcohol evaporate in the case of small worms, or gradually reducing the alcohol content and increasing the glycerol content of the mixture with large worms (>1 cm). Examine arthropod parasites whole.



## 9.0 PROTOCOLS FOR SAMPLING INVERTEBRATES

### 9.1 PREVENTION OF SPREAD OF AQUATIC INVASIVE SPECIES

#### Overview

Ensure specific protocols are followed to prevent the spread of aquatic invasive species when sampling for invertebrates. Ensure specific nets and gear are used for each water body, the following cleaning protocols should be used after retrieving or before setting nets and related gear into a new water body.

#### Sources

Manitoba Water Stewardship (2010)

#### At a glance

- 1** Clean and inspect all nets and gear by removing all plants, animals and mud at the source.
- 2** Rinse nets and gear using high pressure, extremely hot tap water – preferably 50°C (120°F), or dry nets and gear for at least 5 days in the hot sun (if rinsing is not available).
- 3** Alternatively, freeze all nets and gear for two or more days, or soak nets and all equipment in a 1) table salt water solution (230 g (2/3 cup) of salt to 1 L (1 gallon) water) for 24 hours or 2) undiluted white vinegar for 20 minutes, or 3) diluted household bleach solution (> 5% sodium hypochlorite at a concentration of 100 ml (~3 ounces) of bleach to 20 L (~5 gallons) of water) for 60 minutes.

### 9.2 PROTOCOL FOR SAMPLING INVERTEBRATES IN STREAMS

#### Overview

The invertebrate collecting and processing protocols outlined in this document are designed primarily for the intention of collecting specimens for identification purposes. The various collection techniques are partially selective in terms of the species and size classes that each captures. Therefore, the particular method to be used will depend on the purpose of the study and will be outlined in the project design.

The mesh size used to collect/process the invertebrate sample determines the composition of the benthic invertebrate sample collected. In streams and rivers, benthic invertebrates are collected from either erosional or depositional substrates and a variety of samplers are used. Open water benthic invertebrate sampling programs are usually conducted in early spring or fall when benthic communities tend to be the most stable and relatively low flows facilitate sampling. It is also important to maintain consistency of time of sample collection within and between years. There are a number of qualitative and

quantitative sampling techniques each with advantages and disadvantages.

The Drift net sampler can also be used to collect the emerging or drifting invertebrate stages while a Surber sampler can be used for depths less than 30 cm. The Neill or Hess cylinder sampler is one of the most commonly used benthic invertebrate samplers to sample erosional substrates in streams and rivers. This sampler is suited to a range of erosional substrate types such as gravel, cobble, small boulders, and sand. Although, it is limited to a relatively shallow sampling depth in flowing water, a modified version of the Neill cylinder (mesh: 210  $\mu\text{m}$ ; substrate contact area: 0.1  $\text{m}^2$ ) has been used to sample benthic invertebrates in major rivers.

### Sources

Environment Canada (2007), Alberta Environment (2006a), Ontario Ministry of the Environment (2005)

### Special safety concerns

Formalin is used as a preservative and is a suspected carcinogen. It should be used with extreme care and the MSDS should be read.

### Other sources

B. C. WLAP (2003), Environment Canada (1999), EMAN (Undated c)

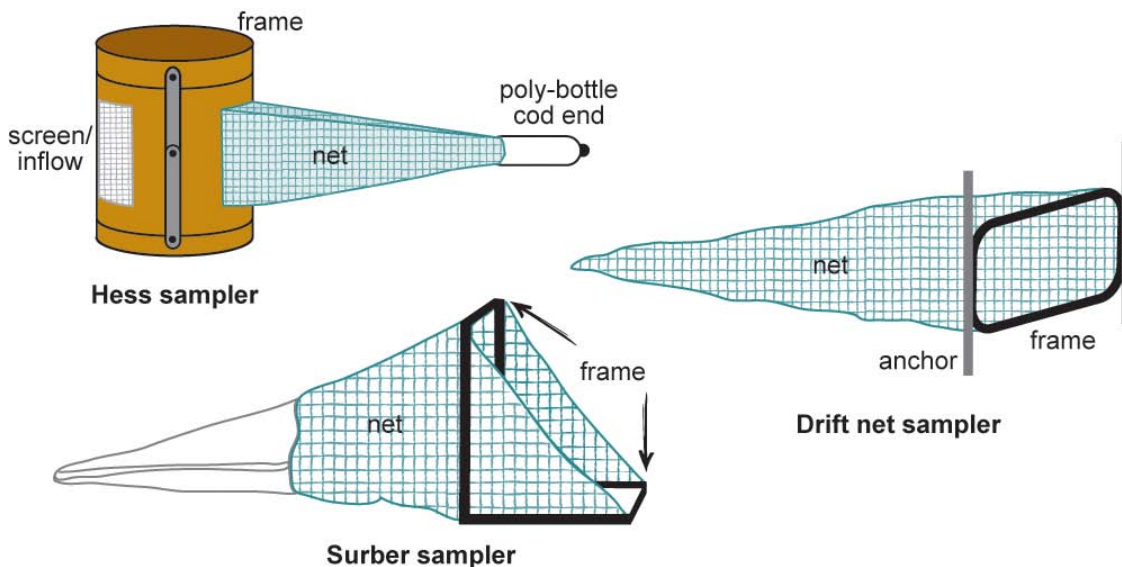

Figure 13. Common types of invertebrate samplers (Alberta Environment (2006) and British Columbia MWLAP (2003))

### 9.3 PROTOCOL FOR SAMPLING INVERTEBRATES WITH A TRAVELLING KICK AND SWEEP – LAKES

#### Overview

The Travelling-Kick-and-Sweep is the standard sampling method; it is typically applied by wading along transects through the habitat of interest, kicking the substrate to dislodge benthos, and collecting dislodged benthos by “sweeping” a hand-held net through the water. Most benthos biomonitoring surveys use a net mesh size between 250 micron and 1 mm but a 500 µm size is common. Samples should be collected at the same time of year at individual sites.

#### Sources

Ontario Ministry of the Environment (2005)

#### At a glance

*lake segments*

*release non-benthic animals*

**1** Choose a set of three representative lake segments (ideally this is done by randomly selecting three from a set of possible locations on a lake), in which a series of transects (running from the water’s edge to the 1 m depth; see Figure 14) will be sampled. These lake segments should be enclosed in the area where aquatic ecosystem condition is questioned.

**2** Use a net (commonly 500 µm mesh) and a Travelling-Kick-and-Sweep along transects to collect the sample. Vigorously kick the substrate to disturb it to a depth of ~5 cm. To collect dislodged materials, sweep the net back and forth and up and down as you move along the transect. Sample for about 10 minutes per replicate, or until you are sure that at least 100 animals have been collected. At least one complete transect (from shore to 1 m depth) must be sampled. Sieve the collected sample in the net. Rinse off and remove large rocks, plant material, etc. Release any non-benthic animals collected. Transfer net contents to a bucket. To prevent the net from clogging, material may need to be transferred several times as you collect each replicate.

**3** Record sampling time (active sampling time only, time spent transferring net contents into the bucket not included), distance, and any other information required on the field sheet.

**4** Repeat until three replicates are collected.

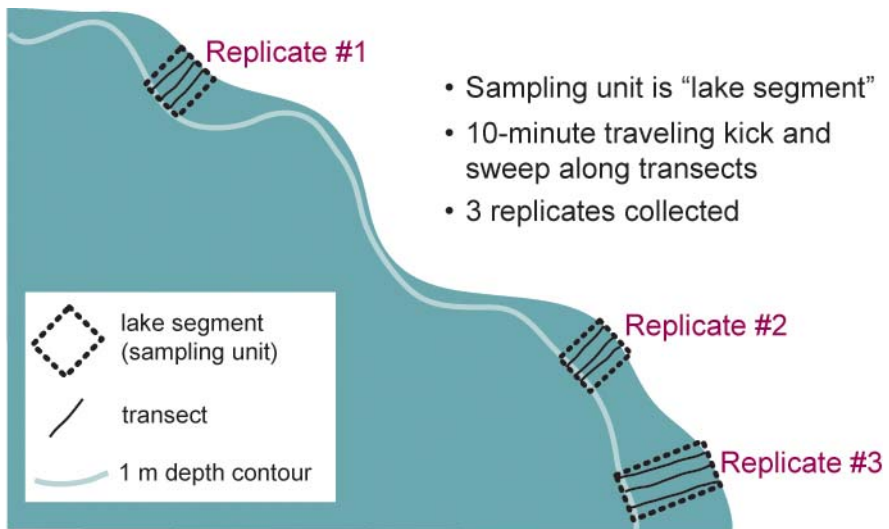

Figure 14. Travelling kick-and-sweep method for lakes  
(Source: Ontario Ministry of the Environment (2005))

## 9.4 PROTOCOL FOR SAMPLING INVERTEBRATES WITH A TRAVELLING KICK AND SWEEP – STREAMS

### Overview

The Travelling-Kick-and-Sweep is the standard sampling method; it is typically applied by wading along transects through the habitat of interest, kicking the substrate to dislodge benthos, and collecting dislodged benthos by “sweeping” a hand-held net through the water. Most benthos biomonitoring surveys use a net mesh size between 250 micron and 1 mm but a 500 µm size is common. Samples should be collected at the same time of year at individual sites.

### Sources

Ontario Ministry of the Environment (2005)

### At a glance

*sweeping motion*

**1** Where possible, identify a sampling unit that contains 2 riffles and 1 pool. In sampling units containing multiple riffles or pools transects should ideally be located randomly. However safety and ease of access must always be considered.

**2** Sample the farthest downstream transect in the Sampling Reach. Place a net downstream from you (commonly 500-µm-mesh with the net held close to the stream bottom). Start the timer and beginning at either the right or left bank, walk along the transect to the opposite bank, vigorously kicking the substrate to disturb it to a depth of ~5 cm. Sweep the net back and forth (both vertically and horizontally through the water column) and keep it downstream from, and close to, the area being disturbed so that dislodged invertebrates will be carried into the net. A good sweeping motion is particularly important in areas of slow current to ensure animals are collected in the net (the sweeping motion is less important when sampling in strong current). Kick-and-sweep about 10 m of the transect in about three minutes (this sampling effort may be reduced if benthos are known to be abundant).

**3** In large rivers using the 3-minute/10 m guideline, sample short segments along the transect (essentially a point-transect approach), in a way that covers the range of current velocities exhibited across the channel cross-section (Figure 17). On the other hand, sticking to the 3-minutes/10 m guideline in small streams requires that several transects be positioned in the same riffle or pool (Figure 18).

**4** Sieve the collected sample in the net. Rinse off and remove from the sample large material like rocks and wood. Release any non-benthic animals collected. Transfer net contents to a bucket. To prevent the net from clogging, material may need to be transferred several times as you sample each transect. Placing your bucket on the side of the stream where you start sampling allows frequent trips to the bucket without disturbing transect

sections not yet sampled.

**5** Record sampling time (active sampling time only, time spent transferring net contents to bucket not included), distance, and all other information required on field sheet.

**6** Move to the next upstream transect and repeat until all transects have been sampled. If non-wadeable portions of the channel cross section are encountered, sample only the safely wadeable portion.

**7** Record the number of transects used, total distance traveled on each transect, total time spent collecting invertebrates, and wetted width at each transect as well as all other information on the field sheet.

**8** Rinse the net and maintain any recovered benthos with the sample.

**9** For large rivers (Figure 17), portions of the transect are selected randomly within each current speed stratum (labeled 1-5) to give an approximate 10 m and 3-minute composite sample for the transect.

**10** For small rivers, additional supplementary transects are located immediately upstream from each pool and riffle transect to provide sufficient sampling distance (i.e., approximately 10 m).

**11** Repeat until three sub-samples are collected.

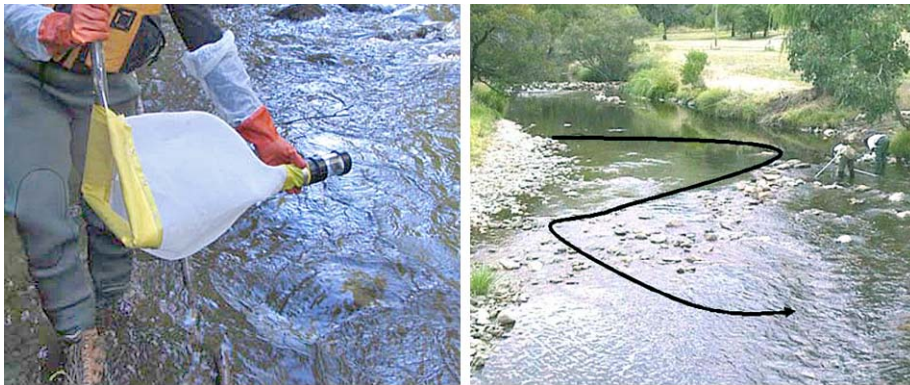

Photo 18 (left): Triangular shaped kick net sampler (400 micron mesh and removable cup) (Source: Environment Canada (2007))

Photo 19 (right): Kick net transect through a riffle (Source: Environment Canada (2007))

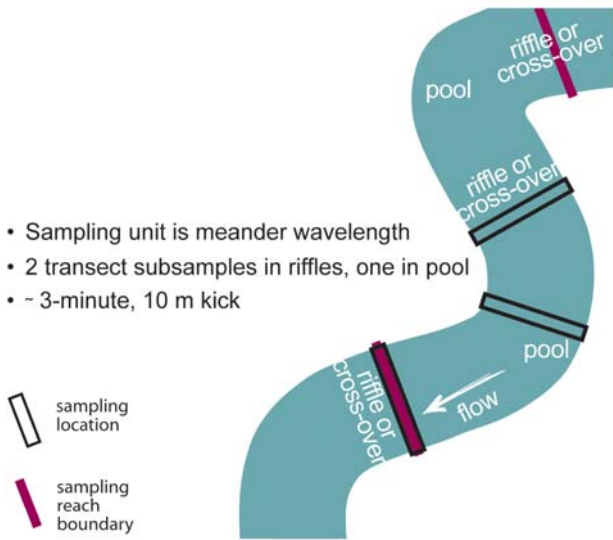

Figure 15. Travelling kick-and-sweep-transect method for wadeable or partially wadeable streams (Source: Ontario Ministry of the Environment (2005))

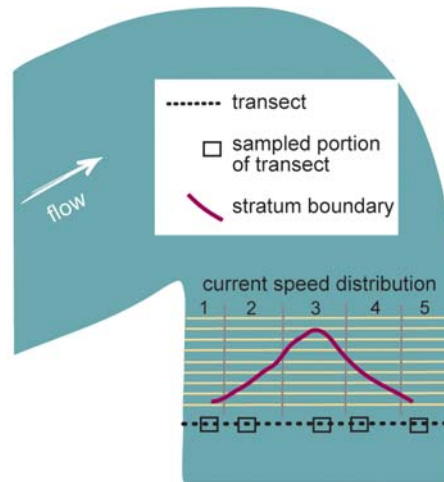

Figure 16. Large river transect kick method (Source: Ontario Ministry of the Environment (2005))

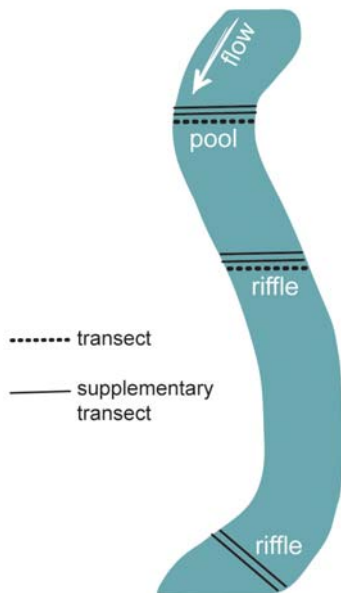

Figure 17. Small river transect kick method (Source: Ontario Ministry of the Environment (2005))

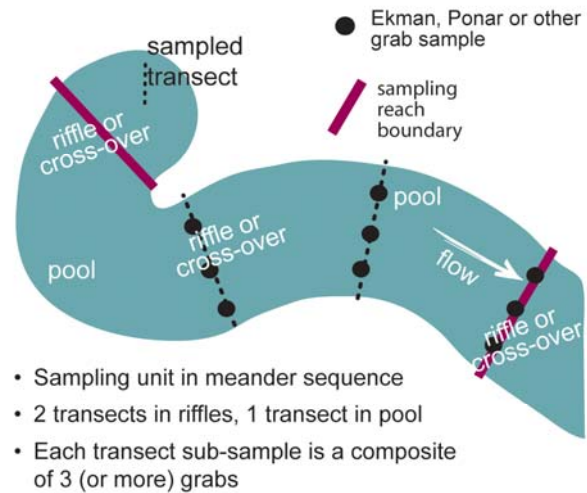

Figure 18. Grab sampling method for non-wadeable streams (Source: Ontario Ministry of the Environment (2005))

## 9.5 PROTOCOL FOR SAMPLING INVERTEBRATES WITH A DRIFT NET SAMPLER

### Overview

Drift net samplers are designed to be anchored in flowing water to capture macro-invertebrates that have migrated or have been dislodged from the bottom surfaces into the current. They are limited to use in small, shallow streams. Ideally, drift nets should span the entire width of the stream that is being sampled. Several nets can be placed across the stream channel to capture all drift organisms and to measure spatial variation in the drift.

### Sources

Alberta Environment (2006), British Columbia MWLAP (2003)

### At a glance

- 1** Anchor drift nets in water sufficiently shallower than they will extend above the water surface. Set drift net samples for the time specified by the project design (the length of time is designed to collect a representative sample, but not so long that flow through the nets becomes impaired by clogging from captured particulate matter).
- 2** Transfer the organisms into pre-labeled sample bottles.
- 3** Preserve with 70% ethanol and place in cooler. Initial fixation may be done with 10% formalin.
- 4** Record time, area of net opening, stream discharge per unit time, and volume of water filtered in the field logbook.



## 9.6 PROTOCOL FOR SAMPLING INVERTEBRATES WITH A SURBER SAMPLER

### Overview

The Surber sampler consists of two interlocking frames that support a capturing net. One frame outlines the area of stream bed to be sampled while the other supports the net. The sampler is intended for use in shallow (30 cm or less) flowing waters. Use tent pegs (hooked) to anchor Surber in fast moving water. Repetitive sampling should be timed (i.e., 5 minutes each for more uniform sampling).

### Sources

Alberta Environment (2006), British Columbia MWLAP (2003)

### At a glance

**1** Choose a wetted width location where substrate is fairly uniform. Provide a description of general habitat (e.g., is this a run, pool, or riffle section, etc.). Position the sampler securely at a random location on the stream bottom parallel to water flow with the net portion downstream. The mesh size of the net should be compatible with the goal of the program. Take care not to disturb the substrate upstream from the sampler.

**2** Carefully turn over and lightly rub all rocks and large stones that lie within the frame. This process dislodges organisms that are clinging to the stones. Examine each large stone for organisms, including larval or pupal cases that may be clinging to the stone before discarding (downstream or to the side of the sampler). In order to maintain comparability between stations, a limit on time spent on handling and rubbing the substrate should be set (5 minutes recommended).

**3** Stir remaining gravel with your hands to a depth of 5 to 10 cm.

**4** Move the sampler upstream to a new randomly selected patch of stream bottom and repeat steps (1) through (3). Continue this process until five patches of stream bottom have been sampled, each upstream from the last. This creates a composite of the five samples. The total area sampled will depend on the size of the sampler (x 5) and should be calculated and recorded in the field logbook.

*repeat steps  
1 through 3*

**5** Return to shore and carefully invert the net into a shallow pan containing stream water. Ensure all invertebrates are rinsed from the net into the pan.

**6** Transfer the organisms into a pre-labeled plastic sample bottle and preserve with 70% ethanol. Rinse sample net after each use.

## 9.7 PROTOCOL FOR SAMPLING INVERTEBRATES WITH A HESS SAMPLER

### Overview

The Hess sampler is a metal cylinder with a screened opening on one side and an opposite opening with a net attached (Figure 13). The sample collector places the Hess sampler in the stream with the screen oriented into the current and the net trailing behind. The water is able to flow freely through the sampler and out through the net. With a known radius, the stream bed area that is sampled is easily calculated. This value must be recorded in the **field logbook**

### Sources

Alberta Environment (2006), British Columbia MWLAP (2003)

### At a glance

*carefully  
rub rocks*

**1** Position the frame securely on the stream bottom. Ensure the screened opening is facing into the current and the net portion is trailing downstream. Hold the sampler in position by applying pressure with your knees. Take care not to disturb the substrate upstream from the sampler.

**2** Reach into the cylinder and carefully turn over and lightly rub all rocks and large stones. This process dislodges organisms that are clinging to the stones and washes them into the net. Examine each stone for organisms, including larval or pupal cases that may be clinging to it before discarding it outside of the cylinder. In order to maintain consistency between samples, a standard time should be assigned to sampling each site (5 minutes recommended).

**3** Stir remaining gravel with your hands to a depth of 5 to 10 cm.

**4** Move the sampler upstream to a new patch of stream bottom and repeat steps (1) through (3). Continue this process until five patches of stream bottom have been sampled, each upstream from the last. This creates a composite sample of the five areas.

**5** Return to shore and carefully wash the contents of the net into the cod-end then transfer to a shallow pan. Ensure all invertebrates are rinsed into the pan.

**6** Transfer the organisms into a pre-labeled sample bottle and preserve with 70% ethanol. Rinse sample net after each use.

## 9.8 PROTOCOL FOR SAMPLING INVERTEBRATES WITH A NEILL SAMPLER

### Overview

The Neill sampler is a metal cylinder with a screened opening on one side and an opposite opening with a net attached (Figure 13).

### Sources

Alberta Environment (2006), British Columbia MWLAP (2003)

### At a glance

*check the seal*

*characterize the benthic habitat of the site*

- 1** Evaluate the study area to determine the dominant substrate type(s). Ensure this substrate is sampled at each site, and choose sites where there is sufficient current to inflate the sampler net.
- 2** Sample in depths of 30 to 50 cm of water.
- 3** Collect five samples per site, either in a transect perpendicular to shore or at random.
- 4** Label five Nalgene bottles with site, date, location, sample number, and sampler's initials.
- 5** Rinse net thoroughly between sample sites.
- 6** Ensure that the net is securely mounted on the Neill cylinder.
- 7** Screw a Nalgene bottle onto the net receptacle.
- 8** Place the loose end of the net with the bottle attached into the top of the cylinder.
- 9** Moving in an upstream direction, select an area of undisturbed substrate to sample.
- 10** Press the sampler into the substrate with the opening opposite the net facing the current. Feel inside the cylinder to ensure that there is a good seal. The teeth of the cylinder should be completely buried in the substrate.
- 11** If the seal is inadequate, rinse the net and bottle clean and select another sampling spot.
- 12** Once the cylinder is firmly anchored in the substrate, hold it there by standing on the lower handles. Flip the net end with the bottle out of the cylinder and into the water.
- 13** Remove any large stones from inside the cylinder. Scrub them gently by hand and rinse them in the cylinder until no invertebrates remain attached to them. OPTIONAL: if not doing a visual characterization of substrate save these rocks to characterize substrate size.
- 14** Using the small shovel, stir the substrate for about 1 minute. Ensure that the net does not clog. Clogging will keep invertebrates from collecting in it. To prevent clogging gently stroke and shake the net.
- 15** Stirring the sediment too vigorously, slow flows, or the net clogging can cause particles to escape out of the upstream opening of the cylinder.
- 16** Let the inflowing water wash all the suspended particles from the cylinder into the net. The water in the cylinder should

become as clear as the river water.

*rinsing the  
net*

**17** Gently stroke the net with your hands so that the particles in it move towards and into the Nalgene bottle.

**18** Lift the cylinder out of the water and repeatedly rinse the net by plunging it in and out of the water. Wash all particles and invertebrates into the Nalgene bottle. Check for any invertebrates caught in the net and make sure they are collected.

**19** Press the netting against the bottle mouth, invert the bottle and pour out most of the water. Turn the bottle right side up and splash the net with water to return any particles clinging to it into the bottle.

**20** Unscrew the Nalgene bottle from the net and preserve the sample with buffered formalin immediately after completing the collections. Add approximately 1 part of full strength buffered formalin to 10 parts of sample (if the sample contains a large amount of organic matter, algae, and invertebrates, add approximately 1/5 the sample volume of buffered formalin).

**21** Determine depth of water at each sample location using a meter stick or calibrated shovel.

**22** Use a current meter to obtain water velocity at 0.6 of total depth from surface, at each sample location. Count the number of revolutions in 60 seconds. Use earphones if water is turbid. Repeat the procedure for the remaining samples. Always sample upstream, and away from disturbed areas.

*photo  
needed*

**23** Take photographs of the site looking both upstream and downstream. Record and collect the following supporting data to characterize the benthic habitat at that site: Water Depth (use a depth sounder, meter stick or velocity meter rod to measure the water depth at the approximate location that the benthic invertebrate sample was collected); Substrate Characterization: (characterize the sediment grain size of erosional substrates by visually estimating the percent aerial coverage of standard particle size categories according to classification systems); and Other: (wetted and bankfull channel widths; GPS coordinates and site description; % macrophyte cover or qualitative description of epilithic algal cover; qualitative description of the amount of silt present). Depending on study design, supporting information may also need to be measured including pH, DO, temperature, and conductivity directly upstream from the approximate location that the benthic invertebrate sample was collected.

### **Under-ice conditions**

**1** Use an ice auger to survey for possible sites, keeping depths, substrate, and flows as similar as possible between sites. Choice of a site may require deeper water than cylinder height; the nylon bag over the cylinder will prevent escape of invertebrates. Water up to 1 m deep may be sampled, depending on flow.

**2** Use chain-saws/augers to excavate a hole in the ice approximately 1 - 1.5 m wide and 2.5 - 3 m long, oriented with long part of hole in direction of flow. Use ice tongs to extract ice blocks, ensuring that substrate is undisturbed. A crew of three is needed to search for and excavate sites for sampling.

**3** Attach guy ropes to bottom handles of cylinder and safety ropes to the two persons in dry suits. Other ends of ropes should be fastened to ice picks pounded into ice for safety. Put shovel through top of cylinder bag and pull drawstring tight around handle.

**4** During ice-removal and entry into the hole, care should be taken not to disturb the benthic area to be sampled.

*3 people are  
needed*

**5** Note that three people are needed to sample efficiently and safely. With one person on ice (upstream of hole) handling the cylinder guy ropes and safety ropes, the samplers enter the downstream end of hole and drill the cylinder into undisturbed substrate.

**6** The cylinder should be drilled into substrate far enough to ensure a good seal. Note that two people are needed in the water to ensure enough downward force to keep the cylinder anchored into substrate. Use the shovel to agitate the substrate at bottom of cylinder for approximately 2 minutes. Allow the cylinder to sit for 2-3 minutes to allow invertebrates to drift into net and bottle. Stroke net to prevent clogging.

**7** Haul the cylinder out of water. Process the sample following open water procedures described in the previous protocol and put a new bottle onto net. The other person in the water will do a velocity measurement with current meter at the sample location as well as a depth measurement. Often, biofilm samples are required in triplicate from each hole, so nine rocks need to be collected.

**8** Take necessary precautions to ensure that samples are not frozen during handling and storage. Samples can be stored in an insulated container (e.g., cooler) equipped with hot water bottles.

*photo  
needed*

**9** Take a photograph at each site and record supporting information such as: GPS coordinates, water velocity and depth, ice depth, and substrate characteristics (visual assessment).

**10** Proceed upstream of first replicate location about one pace to obtain undisturbed substrate, and repeat the sampling procedure. The opening should allow collection of five replicates.

## 9.9 PROTOCOL FOR SAMPLING INVERTEBRATES WITH A GRAB SAMPLE

### Overview

The grab sampling method yields a composite transect-kick-like sample for each pool and riffle transect in the sampling unit (Figure 19). Grab sampling is most often done in slow, deep, non-wadeable streams. See the protocol in the Manual for sampling in soft sediments.

### Sources

Ontario Ministry of the Environment (2005)

### Special safety concerns

Formalin is used as a preservative and has been identified as a suspected carcinogen. Formalin should be used with extreme care and the MSDS should be read.

### At a glance

*at least 3  
grab  
samples*

**1** Use a dredge (as outlined in the Section of the Manual for sampling in soft sediments).

**2** Select two riffles and one pool transects.

**3** Sampling from a boat, bridge, or similar vantage point that allows access across the stream cross section, collect and pool at least three grab (e.g., Ekman dredge or Ponar grab) samples per transect to ensure 100 animals are collected. Use an Ekman dredge or Ponar grab in fine sediments where jaw closure is not a problem. A Ponar Grab can be used in most other cases. Other types of equipment can be used where appropriate. Record sampling device on the field sheet and provide device specifications.

**4** Rinse the sampling gear into the sample collection bucket. Rinse and discard any large substrate features collected with the sample. Release any non-benthos animals collected.

**5** Record the number of grabs pooled per transect and all other information required on the field sheet.

## 9.10 PROTOCOL FOR SAMPLING INVERTEBRATES WITH ARTIFICIAL SUBSTRATES

### Overview

Artificial substrates are placed in the stream so it is colonized by the organisms in the stream then removed later and analyzed. These types of samplers are best suited for upstream/ downstream studies or to test for changes over time. They do not necessarily provide a representative sample of the actual community that is living in the stream. Advantages and disadvantages are:

#### **Advantages with artificial substrates:**

- Access to areas that can't be sampled because of substrate or depth,
- Reduced variability,
- Non-destructive sampling of a location, and
- Flexibility in sampling design.

#### **Disadvantages with artificial substrates:**

- Colonization rates differ from site to site,
- Species in sampler may be different than stream bottom,
- Long incubation/exposure times (6-10 weeks), and
- Vulnerability of samplers to vandalism.

The most frequently used artificial substrate sampler is the "barbecue basket" sampler which is made by filling a basket (available in a number of variations from hardware stores) with gravel (2.5 to 7.5 cm diameter) that is then placed in the stream bottom. The substrate becomes colonized and is removed after some predetermined length of time.

### Sources

British Columbia MWLAP (2003)

### Special safety concerns

Formalin is used as a preservative and has been identified as a suspected carcinogen. Formalin should be used with extreme care and the MSDS should be read.

### At a glance

*be careful  
not to  
dislodge  
organisms*

**1** Place the basket sampler in the stream and anchor if necessary. Leave in place for the necessary colonization time.

**2** When the samplers are removed, take particular care not to dislodge organisms from the sampler. A general technique is to carefully place the basket sampler in a plastic bag underneath the water before it is lifted out.

**3** Record time, any site related data such as flow, temperature, and pH (see the Ambient Freshwater and Effluent Sampling chapter), and any data about the appearance and condition of the basket sampler in the **field logbook**.

**4** In the laboratory, remove the organisms from the sampler by carefully washing each rock into a sieve. Transfer the organisms into pre-labeled sample bottles. Preserve with 70% ethanol and place in cooler. Initial fixation may be done with 10% formalin

before transfer to ethanol for longer term storage.

**Other sources**

Environment Canada (2007), Alberta Environment (2003 a), Ontario Ministry of the Environment (2005), Environment Canada (1999), EMAN (Undated c)

## 9.11 PROTOCOL FOR SAMPLING INVERTEBRATES IN WETLANDS

**Overview**

The grab sampling method yields a composite transect-kick-like sample for each pool and riffle transect in the sampling unit (Figure 19). Grab sampling is most often done in slow, deep, non-wadeable streams. See the protocol in the Manual for sampling in soft sediments.

**Sources**

Ontario Ministry of the Environment (2005)

**Special safety concerns**

Formalin is used as a preservative and has been identified as a suspected carcinogen. Formalin should be used with extreme care and the MSDS should be read.

**At a glance**

*transfer net contents frequently*

### Travelling Kick and Sweep

- 1** Plan a set of transects within a Wetland Segment.
- 2** Use a net (commonly 500 µm mesh) and walk along wadeable transects, vigorously kicking the substrate to dislodge benthos and bottom materials. Sweep the net through the water column to catch dislodged material. Transfer net contents to a bucket frequently to prevent the net from clogging.
- 3** Continue to sample transects for 10 minutes or until 100 animals have been collected. At least one transect that spans the length of the Wetland Segment should be sampled. Record time spent sampling, distance covered, and any other information required on the field sheet.
- 4** Thoroughly rinse net contents into a bucket.
- 5** Repeat steps 2 to 4 for each replicate.

### Jab and Sweep

*3 or more jabs per replicate*

- 1** Select locations for jab and sweep sampling within a Wetland Segment
- 2** Jab a D-net (commonly 500 µm mesh) into the substrate to a depth of 5 cm and sweep it forward until the net fills with disturbed material. Pool three or more jab and sweeps per replicate to ensure that at least 100 animals are collected.
- 3** Record the number of jab and sweep samples pooled per replicate as well as other information required on field sheet.
- 4** Thoroughly rinse net contents into a bucket.
- 5** Repeat steps 2 to 4 for each replicate.



### Coring

**1** Record corer specifications on the field sheet.

**2** Probe the ground first with a small diameter steel wire to ensure the absence of large rocks or other materials that cannot be cored. Lubricate walls of corer with cooking spray. Twist corer to penetrate substrate to a depth of about 10 cm. Remove the corer from the soil using a rocking motion until the bottom breaks free. Gently lift the corer, placing a hand over the bottom opening to prevent the sample from falling out. Pool a minimum of three cores per replicate to ensure at least 100 animals are collected. Take more samples if it appears that less than 100 animals have been collected.

*use rocking motion*

**3** Rinse the corer into a bucket.

**4** Continue sampling until three replicate samples are collected.

**5** Record the number of cores pooled per replicate, corer specifications, and other information required on field sheet.

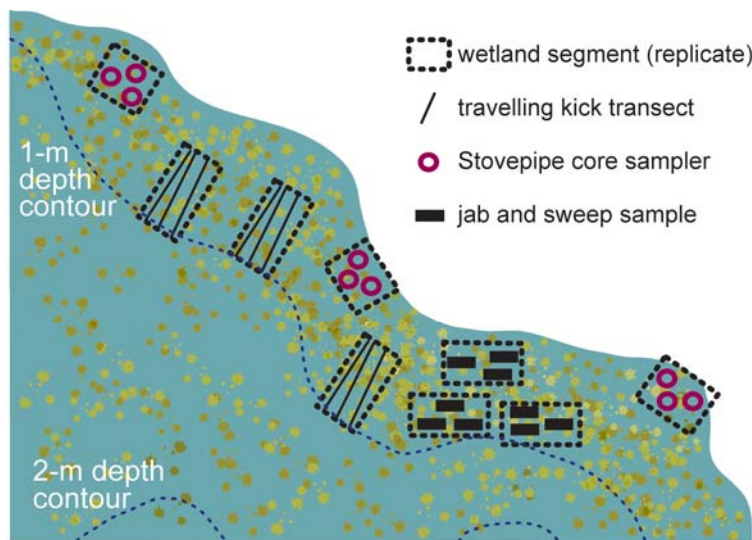

Figure 19. Wetland benthos collection methods  
(Source: Ontario Ministry of the Environment (2005))

## 9.12 PROTOCOL FOR SAMPLING INVERTEBRATES IN SOFT SEDIMENTS

### Overview

Open water benthic invertebrate sampling involves the collection of invertebrates that inhabit the upper sediment layers and the sediment surface. Typically macroinvertebrates are sampled with some meiofauna including early insect instars. Meiofauna is defined as microscopic animals that pass through 500 µm screen but are retained by a 64 µm screen. The mesh size used to collect/process the invertebrate sample determines the composition of the benthic invertebrate sample collected. Some depositional areas in rivers and streams as well as lakes and reservoirs are most suited to the use of Ponar or Ekman grab samplers for sediment collection. Ponar grab samplers are most efficient at sampling harder sediments while Ekman grab samplers are most efficient in softer sediments. Open water benthic invertebrate sampling programs are usually conducted in early spring or late fall when benthic communities tend to be the most stable. It is also important to maintain consistency of time of sample collection within and between years.

### Sources

Alberta Environment (2006 a), Ontario Ministry of the Environment (2005), Environment Canada (1999)

### Special safety concerns

Formalin is used as a preservative and has been identified as a suspected carcinogen. Formalin should be used with extreme care and the MSDS should be read.

### At a glance

- 1** Label the sample containers with site identification, sample type, sampling method, sampler ID, and the date of collection. Take a photograph of the site.
- info to be noted*  
**2** Note the following site information in the field sheet/book: target and actual sampling location (GPS), date and time of sample collection, overlying water depth (m), ambient weather conditions, grab penetration depth, depth sub-sampled, sampling personnel, and any deviations from the field sampling procedure (FSP), macrophyte growth.
- 3** Ensure that the dredge jaws open and close properly.
- do not allow sampler to free fall*  
**4** Lock the dredge jaws in the open position and lower in a controlled fashion to the lake bottom. Do not allow the sampler to “free fall” The sampler should be in contact with the substrate or positioned just above it
- criteria for acceptable sample*  
**5** Drop the messenger (if applicable) and first slowly then quickly raise the dredge to the surface.
- 6** The sample is deemed acceptable if the desired depth of penetration has been achieved, the sampler has completely closed and was not inserted on an angle or tilted upon retrieval. If the sample does not meet these criteria the sample should be retaken close to the original sampling location. The rejected

sample should be discarded in such a way that it will not affect subsequent sampling efforts.

**7** Place a container/bucket beneath the sampler just as it breaks the water surface.

**8** Open the grab sampler over a 250 or 210 µm mesh sieve box. If substrate materials are predominately fines, gently wash the sample using the sieve box to release the fine sediment and transfer the contents retained on the sieve to pre-labeled 1 L plastic jar(s). Use more than one jar if the sample is large.

*on-site  
sieving*

**9** If substrates include significant amounts of coarse material or organic debris, on-site sieving may be impractical. In this case, samples may be double-bagged, labeled, kept cool, and transported to a laboratory for sieving (i.e., with the aid of pressurized water). If samples can be kept cool and processed in a laboratory within a few days they may be preserved after sieving, otherwise the samples should be preserved at the time of collection.

**10** Add buffered formalin to the sample(s) to achieve a final concentration of 10%. If the sample contains a large amount of organic matter, algae, and invertebrates, add approximately 1/5 the sample volume of buffered formalin.

**11** Add a waterproof label with the sample ID to each sample jar (in addition to an external label) and securely cap the jar(s). Agitate the jar(s) to ensure the formalin is evenly distributed throughout the sample(s).

**12** Rinse the grab sampler and the sieve in lake water to thoroughly remove residual sediment, invertebrates, or plant material.

**13** Site photographs may be taken if they aid in site characterization (e.g., near-shore sites or sites with aquatic plant growth). In addition, supporting data must also be collected to characterize the benthic habitat at that site.

## Other sources

B. C. WLAP (2003), EMAN (Undated c), Environment Canada (Undated b)

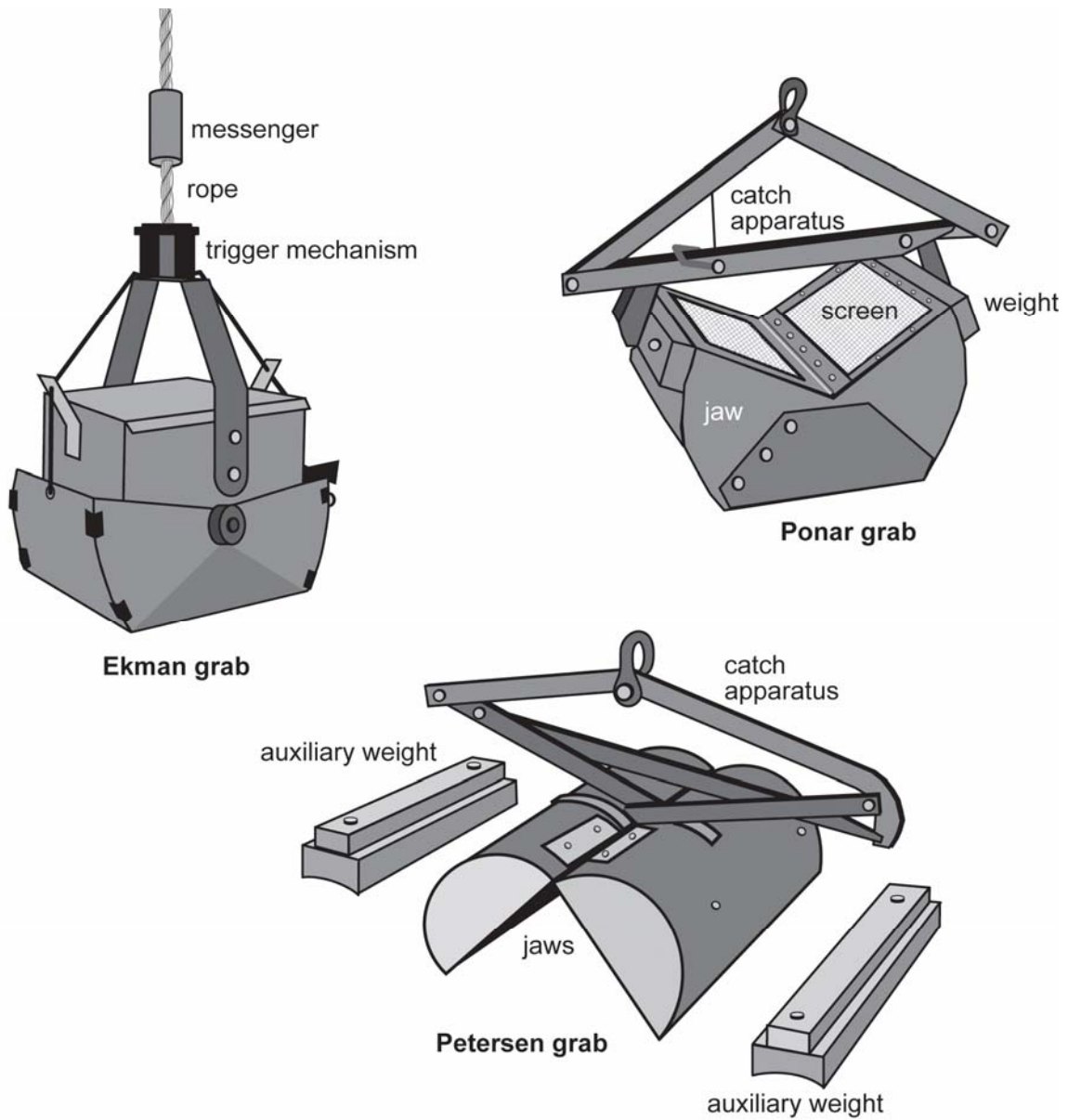

Figure 20. Samplers used for soft sediments (Source: British Columbia WLAP (2003))

## 9.13 PROTOCOL FOR INVERTEBRATE SAMPLE PROCESSING

### Overview

Samples should be sieved in the net in the field. At this time, rocks, wood, leaves, and other large items found in the sample may be discarded after removing all attached benthos. Also remove and release any non-benthos animals collected (e.g., fish). If samples are to be picked live, they should be kept cool and should be processed within 48 hours. For transportation to the laboratory, decant bucket contents into a wide-mouth plastic jar to avoid spills during transportation and to conserve refrigerator space (a consideration when samples will be picked live). Label samples with lake, stream, or wetland name and/or code, date, and sample number. Insert labels in the vessel containing the sample in case labels get washed off the container; regular paper and pencil work fine for this purpose.

Samples may be preserved with 10% buffered formalin (a good fixative) as long as safety precautions are observed. Alcohol (e.g., ethanol, methanol, isopropanol) can also be used to preserve samples. If buffered formalin is used for initial fixation, replace it with alcohol after a couple of days to prevent hard body parts (e.g., clam and snail shells) from dissolving. When using alcohol for preservation in the field, a good method is to first sieve the sample to remove much of the water, transfer to a suitable container, and then add a generous amount of alcohol.

### Sources

Ontario Ministry of the Environment (2005)

### At a glance

*remove fines*

#### Sieving the sample

- 1** Remove fine particulate matter and preservative from the sample prior to picking benthos. Fines cloud the water in sorting trays, making the task of finding animals much more difficult.
- 2** Transfer the sample to a 500 µm sieve (500 µm D-net can be used as a sieve) and rinse well with water to remove preservative (if used) and fine suspended particles.
- 3** Thoroughly rinse and discard large items such as pieces of wood, rocks, and leaves.
- 4** Rinsate from preserved samples will be sufficiently dilute and of low enough volume to permit disposal via a septic system or municipal sewage system. When disposing sample preservative to a septic system, keep daily 10% formalin discharge to 10 L or less.

#### Obtaining benthos sub-samples

- 1** Sub-sampling is a method of removing manageable portions of the sample so that invertebrates can be more easily separated

from debris in the sample and to obtain fixed count samples.

### Bucket method

**1** Wash the sample from the sieve back into a large container (a bucket works well). Gently swirl the bucket contents to indiscriminately distribute the sample. Randomly remove a small quantity of the sample (using a spoon, ladle or similar gadget) and transfer it to a suitable container.

### Marchant Box method

*live samples*

**1** Wash the sample from the sieve into the Marchant Box and fill with water to a depth just below the height of the walls dividing the cells. Water depth is important. In the case of live samples, water deeper than the dividing walls will allow animals to swim between the cells once the contents have been randomized. Less water will make it difficult to distribute the sample among the 100 cells.

**2** Close and fasten the lid. Invert and gently mix the sample with side-to-side rocking motions. Right the box quickly and set on a level surface to let contents settle into cells. Using random numbers for the 10 columns and 10 rows, arbitrarily select one or more cells and transfer contents to a suitable container or Petri dish using a pipette (or turkey baster), vacuum pump, or aspirator and suction flask, or similar method.

**3** The cell-extraction method used for Marchant sub-sampling strongly influences sample-processing time. Consider the costs of more sophisticated equipment such as aspirators, pumps, suction flasks, and tubing in relation to the improved efficiency resulting from their use. Using an aspirator and suction flask may be the best balance between minimal cost and extraction efficiency.

### Picking, identifying, enumerating and preserving benthos

*at least 100 animals*

**1** Sub-samples should be sequentially removed and picked until at least 100 animals are retained from each sample. 100-animal fixed counts yield reliable estimates of relative abundance and allow samples to be processed relatively quickly (as opposed to full enumerations). In sparse samples (i.e., containing fewer than 100 animals), the entire sample is processed. If fewer than 80 animals are collected, re-sample.

**2** To be counted, a specimen must have enough intact body parts to permit its identification to the targeted level, and it must have a head (this prevents double counting). Larval exuviate and empty shells (e.g., snails and clams) and cases (e.g., of caddis flies) are not counted.

**3** To identify, tally and preserve benthos as they are picked from the sample, transfer a sub-sample into a suitable picking

*when  
picking live,  
speed is  
important*

container such as a Petri dish or a white tray. Add additional water to the tray to aid sorting. Sort through the sample, removing all benthos. Identify and tally animals as these are removed; however, when picking live, speed is important so identify animals after all samples are picked. Set aside specimens that require detailed observation to identify for later identification. The minimum detail for identification is a coarse 27 group mix of Phyla, Orders, Classes and Families.

**4** Place animals into a labeled container with alcohol preservative after they are identified and tallied. Glass jars with lids that give a good seal are commonly used. Animals that cannot be identified should be archived with the rest of the sample; their presence should be recorded on the tally sheet as unknown, but their count is not considered part of the 100-animal sub-sample.

**5** Continue picking the sub-sample until all benthos have been removed (no more animals are found during a reasonable period of searching).

**6** Continue to sort and identify animals until at least 100 invertebrates have been tallied. The entire sub-sample that contains the 100<sup>th</sup> animal must be picked in its entirety to allow abundance estimation.

## 9.14 PROTOCOL FOR SAMPLING INVERTEBRATES FOR TISSUE

### Overview

The sampling of benthic invertebrates for tissue contaminant analysis is useful because it provides an indication of exposure or the bioavailability of contaminants in the sediment/water to biota. The sampling of contaminants in benthic invertebrates provides a measure of the current status of contaminants in the aquatic system. Yet it is important to note that this does not demonstrate that the contaminant is causing a detrimental effect to the organism it is simply a measure of exposure. Specifically, the determination of contaminant bioaccumulation in benthic invertebrates identifies the presence and concentration of contaminants in whole organisms, or specific organs and tissues, depending on the study objective and logistics.

### Sources

Alberta Environment (2006 a)

### At a glance

*rinse  
invertebrates*

- 1** One person will hold the screen/net into the current of the stream and another person will disturb the upstream substrate with feet and/or hand.
- 2** Bring nets/screens to shore. Place the net contents into several pans for easier sorting of invertebrates; screens can be examined directly.
- 3** Pick out the target invertebrates for tissue analysis. Candidates for tissue analysis will depend on study objectives and design.
- 4** Invertebrates of different taxonomic groups (Order, Family, or Genus) can either be a composite in one container, or into separate containers using forceps. Rinse the invertebrates with stream water (passed through the sampling mesh) prior to putting them into the sample containers to remove attached debris/sediment.
- 5** Sample container should be labeled with site name, date, taxonomic group, and analysis required.
- 6** Samples should be stored on dry ice immediately and deep frozen to -70°C within 24 hours.
- 7** Adequate notes should be kept describing site conditions, substrate, physical variables (temp, pH, DO, conductivity), and site latitude/longitude.
- 8** Variations of this protocol may incorporate gut depuration/clearance procedures and procedures to remove contaminants adsorbed to the surface of the sampled invertebrates. The objectives of the study will determine the variations required.



## 9.15 PROTOCOL FOR BIVALVE AND MOLLUSC SAMPLING

### Overview

Comprehensive surveys are carried out to determine the status of shellfish growing waters. Annual review surveys are less intense in nature; they are conducted to update the classification of an area. Annual review surveys can confirm that sanitary conditions have not changed and that the classification is still valid. A re-evaluation survey updates the classification of the area. This may involve an in-depth assessment of the elements in the comprehensive survey. The complexity and extent of a re-evaluation survey will be specific for each area.

### Sources

CFIA, Environment Canada, and DFO (2008)

### At a glance

#### Comprehensive surveys

*minimum 15 samples*

**1** Conduct bacteriological monitoring under varied environmental conditions. The number and location of sampling stations selected should be adequate to produce the data necessary to effectively evaluate all point and non-point sources of pollution.

**2** A minimum of 15 samples shall be collected at each station. In remote shellfish growing areas this requirement may be modified if warranted by the sanitary conditions in the area.

**3** In certain circumstances, an alternative sampling strategy, systematic random sampling, may be followed. All sampling requirements, i.e. standards, sampling frequency, and data analysis are as outlined in the "National Shellfish Sanitation Program Guide for the Control of Molluscan Shellfish, 2003".

#### Annual review survey

**1** Review files to evaluate the changes in existing and new pollution sources.

**2** Perform a shoreline sanitary investigation and/or bacteriological sampling at representative stations (if deemed necessary).

#### Re-evaluation survey

**1** Conduct bacteriological monitoring under varied environmental conditions. The number and location of sampling stations selected should be adequate to produce the data necessary to effectively evaluate all point and non-point sources of pollution.

**2** Collect a minimum of 5 samples at each station.

**3** Analyze (a minimum of) the last 15 water samples from each representative station to determine the appropriate classification for the area

## 10.0 PROTOCOLS FOR IN-SITU SAMPLING

### 10.1 PROTOCOL FOR IN-SITU SALMONID EGG BIOASSAYS

#### Overview

Developing embryos have periods of extreme sensitivity when their susceptibility to foreign toxicants is maximal. Fish embryos are no different with extensive data from life cycle toxicity testing to support this. The method described below is based upon starting the bioassay with Pacific Salmonid eggs that have just come into the "eyed stage" of development (the stage between the time the eyes become visible and hatching occurs). This stage of development guarantees that the eggs have been fertilized and that the embryos are hardy enough to be handled and transported. Developmental stages prior to this are extremely sensitive to handling and transportation; mortality rates associated with these factors are very high.

#### Sources

British Columbia MWLAP (2003)

#### At a glance

*100 eggs  
per box*

*computer  
program*

**1** Fill egg boxes in the laboratory prior to traveling to the field location; 100 eggs/box. Use a beverage cooler to transport charged boxes to the deployment site. Keep eggs out of direct sunlight since the duration (exposure period) and development of eggs are subject to temperature.

**2** Different salmonid species have different rates of development. A computer program, "SALMONID INCUBATION PROGRAMME, VERSION 1.3, DFO, PBS NANAIMO, BY J.O.T. JENSEN", is an excellent way to estimate the study exposure period. The bioassay can have several end-points. The most common end-point is to terminate the study after controls hatch or, the study can be extended with continuing the exposure until the control alevins "button up". The latter will provide a longer exposure period; however, maximum exposure should be to the development stage of "yolk sac absorption or buttoning up" (terminate the bioassay).

**3** Excavate the site location to a level and position that ensures the wire cage is slightly angled up current. Ensure that when the egg box is positioned inside the wire cage, it is level with the stream bed-water interface. Ensure that the location will always have water flowing over the eggs.

**4** Place the egg box in the middle of the wire cage and add clean spawning size gravel. (Customized neoprene divers gloves work well for holding the egg box in place while gravel is poured into the cage.)

**5** Close the wire cage and seal it with wire or nylon zap straps once the egg box is totally covered with gravel. Use a minimum of 3 boxes per site.

**6** Measure field parameters such as temperature, dissolved

oxygen and pH each time the eggs are checked. Record water flow rates and climatological factors. Place control boxes in conditions (temperature, depth, light) as similar to test boxes as possible.

**7** Designate one cage at each site as the "check cage". This cage should be the only one observed during the weekly monitoring of the study. When checking these eggs, shield them from direct sunlight. The checking should be conducted as quickly as possible. If a longer time (10+ minutes) is required, keep eggs moist.

**8** Record mortality and any other pertinent observations in field note book.

## 10.2 PROTOCOL FOR IN-SITU CAGED FISH BIOASSAYS

### Overview

Under certain conditions, it is possible to use caged fish to determine if deleterious effects are happening in receiving waters. The deployment of caged fish into fresh and marine waters will usually only provide the investigator with a measure of mortality. The species of fish exposed must be relevant to the site's environment, they can be from indigenous or cultured stocks. Various species of salmonids are available, the age and size of the salmonids is often seasonal and species dependent. There are also private trout farms that will provide stocks.

### Sources

British Columbia MWLAP (2003)

### At a glance

*avoid direct  
sunlight*

*do not  
overcrowd  
fish*

- 1** Transport fish in clean and disinfected containers (i.e., Wescodyn or Rocol) that can be sealed. Provide a portable compressed air system or bottled oxygen when traveling any great distance. Temperature will also play an important factor in the summer months during transit.
- 2** Cool using de-chlorinated ice blocks. The fish supplier should provide you with a statement regarding the stocks' origin and any disease treatments they have undergone.
- 3** Ensure the cage is capable of sustaining fish for the duration of the exposure. The cage should allow adequate flow but ensure the fish can not escape.
- 4** Position and secure cages prior to adding the fish. The control location should resemble the sampling location with regard to flow rate, geography, depth, etc. In swift flowing water, position cages in back eddies or side pools, so fish are not under constant current swimming stress. Try to position cages out of direct sunlight. Cage floats must be brightly colored to avoid navigation hazards for boaters.
- 5** Transport fish to the cage site in a sealed bucket to prevent loss. Do not overcrowd the fish in the bucket. The number of fish added to each cage is dependent on size and mass. Count and gently add fish to the cage. If there is a temperature gradient difference greater than three degrees from the field location to transportation water, slowly add upstream water to acclimate the stocks over a 1-hour period.
- 6** Sacrifice a representative number of test fish from the general test stock to measure length and weight. The potential for histological comparison is also a possibility, particularly using gill structures.
- 7** Record field parameters such as DO, pH, conductivity, salinity, and temperature and estimate flow if possible.
- 8** Establish a feeding schedule if testing will exceed four days. Use yearling fish for long term exposure studies.

## 11.0 PROTOCOLS FOR SAMPLING MACROPHYTES

### 11.1 PROTOCOL FOR SAMPLING MACROPHYTES IN LAKES

#### Overview

These methods represent an amalgam of elements from various approaches. Aquatic macrophytes are sampled to: inventory species (presence/absence), identify invasive species, for biodiversity studies and aquatic health assessments, for primary productivity assessments, and bio-monitoring to determine the effects of environmental change or anthropogenic stressors. Field studies may be qualitative or quantitative in nature and appropriate survey methodology is typically selected on the basis of project-specific objectives. Generally, the whole plant should be collected for taxonomy. Some species groups can only be identified by mature fruits or flowers. Small plants like the duckweeds do not make acceptable pressed and dried specimens. Therefore, small screw cap vials make good collecting and preservation containers.

The sampling protocols are applicable to wetlands, ponds, lakes, reservoirs, and large river surveys. Consideration must also be given to the type of water body (i.e., lotic versus lentic, size of water body or study area, littoral extent, and depth) and the nature of the aquatic plant communities to be sampled (see Table 5).

OBJECTIVE	METHODS	DESCRIPTION
Reconnaissance	Surface Inventory	Qualitative
Species Inventory/Biodiversity	Surface Inventory	Qualitative
	Point Intercept	Qualitative/ Semi Quantitative
	Line Intercept	Qualitative/ Semi Quantitative
Biomass/Productivity/ Bio-Monitoring	Transect with Quadrat	Quantitative

Table 5. Summary of macrophyte methods in relation to study objectives

Field staff should be familiar with regional aquatic macrophyte species and the use of plant identification keys. Plants fall into three generalized categories:

- *submergent* - entire plants submerged (Photo 20);

- *floating-leaved* - plants with submerged parts and leaves that float at the surface (Photo 21); and
- *emergent* – plants with erect parts (stems and leaves) that rise above the water surface (Photo 22).

Within all three categories, all rooted vascular plants should be considered. Macro-algae (i.e., *Chara* sp. and *Nitella* sp.) are similar to vascular aquatic macrophytes in size, form and function, and should be treated the same. Filamentous algae, aquatic mosses, and free-floating vascular plants (e.g., *Lemna* sp.) should be recorded when present, but quantification is subject to specific study design. Identify plants in the field whenever possible, but also be knowledgeable in the preparation and preservation of aquatic macrophytes for office identification, or if need be submission to a qualified plant taxonomist. Specific study designs may also require retention of reference collections. Be aware of invasive/exotic, rare and endangered species. It is also important to be able to identify invasive, rare or endangered species.

When possible conduct surveys during the peak growing season (i.e., mid-summer to early fall). There is the likelihood that surface inventories or other reconnaissance surveys may be conducted outside of the peak growing season (if plant growth has progressed enough to permit determination of bed extent and species identification). Many aquatic macrophytes are difficult to identify prior to the development of inflorescences or seed stages.

## Sources

British Columbia MWLAP (2003), Alberta Environment (2006 a), Développement durable, Environnement et Parcs, Gouvernement du Québec (2007)



Photo 20. Example of submerged macrophytes (Source: Richard Carignan, University of Montreal)



Photo 21: Example of floating-leaved macrophytes (Source: Développement durable, Environnement et Parcs, Gouvernement du Québec (2007)).



Photo 22. Example of emergent macrophytes (Source: Développement durable, Environnement et Parcs, Gouvernement du Québec (2007))

## 11.2 PROTOCOL FOR MACROPHYTE SURFACE INVENTORY

### Overview

Surface inventories provide a qualitative method of collecting data for production of plant species or community distribution maps. The end products for a surface inventory include a map showing the distribution of plant bed types, a list of species for each plant bed type and the water body or study area as a whole. In many cases, surface inventories may serve as reconnaissance surveys. Surface inventories are adequate to document gross changes in community structure or the extent of plant beds over time. Surface inventories can also serve as the initial step in supporting more intensive aquatic macrophyte surveys.

### Sources

British Columbia MWLAP (2003), Alberta Environment (2006 a), Développement durable, Environnement et Parcs, Gouvernement du Québec (2007)

### At a glance

*determine  
littoral zone*

**1** Perform a preliminary determination of the littoral zone (the shallow, shoreline, regions of a water body where light penetrates to the bottom permitting colonization by rooted aquatic macrophytes and benthic algae). Small or shallow water bodies may be littoral throughout, while large or deeper water bodies may be littoral only around the margins or in shoal areas. Maximum depth of aquatic macrophyte growth is usually limited by light penetration (i.e., the euphotic zone) but may also be limited by other factors such as slope and substrate type. In rivers, aquatic macrophyte growth is often limited by substrate type and flow velocity, and plant beds are usually restricted to river margins.

**2** Survey littoral regions around lake shores or along river banks by navigating the boat in a zig-zag pattern (Figure 21); from shallow near-shore waters out to the extent of plant beds. Pattern density (i.e., distance between passes) is dependant on visibility but should allow complete coverage for visual assessment. Survey shoal areas with aquatic plant growth separately, and do not survey shorelines without plant growth.

**3** Survey shallow water bodies with littoral plant growth throughout in a grid pattern. Ensure the grid density is dependent on study design, the area to be surveyed and time constraints.

**4** Employ GPS tracking feature (if available) to provide an accurate record of the survey pattern and the area traversed. Record all key features such as, plant bed boundaries or transitions from one plant community type to another and UTM GPS waypoints, Describe key features in a notebook or field sheets.

*information  
to record*

**5** Record water depth, Secchi depth, turbidity, and bottom light level (if equipment is available) at all key feature waypoints. Record GPS coordinates periodically at representative sites within plant beds. Record water temperature and water profiles



at several shallow and deep sites.

**6** Identify and record all plants found within beds. For a qualitative inventory survey, record presence of plants only.

**7** In shallow water with adequate visibility, identify plants by observation from the boat. In deeper or murkier water or where a canopy of plants obscures plants at lower levels, use an underwater viewer.

**8** Collect plant samples at intervals at each plant bed with the rake sampler for closer examination. Identify plants on-site or retain them for identity verification at a later time. Place collected plants in a sealable plastic bag along with a label providing all pertinent information. Record sample collections in a note book or on field sheets along with all pertinent site information and GPS location.

**9** Obtain supplementary information from the very shallow near-shore waters from the shoreline or by wading into the water.

**10** Ensure all samples are properly preserved in a plant press. Samples will be archived or included in reference collections

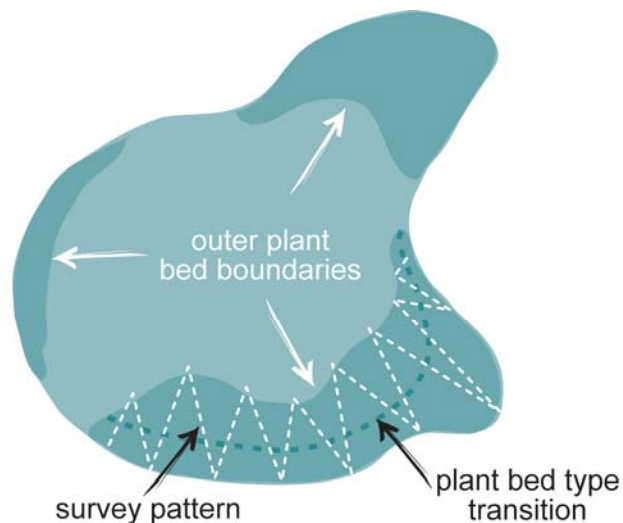

Figure 21. Example of a possible survey pattern for a surface inventory conducted on a small lake (Alberta Environment (2006a))

## 11.3 PROTOCOL FOR POINT INTERCEPT MACROPHYTE SURVEYS

### Overview

Point Intercept surveys are conducted by sampling for aquatic macrophytes at regularly spaced, pre-selected points in a grid pattern. The survey data can be used to identify and delineate plant communities or bed types. The end products for a qualitative Point Intercept survey include a map showing the distribution of plant bed types plus a list of species for each plant bed type and the water body or study area as a whole. Conduct surveys over an entire water body or a discrete area within a water body, but either way survey an entire study area without reliance on subjective site selection in the field. Determine the grid node (i.e., sampling site) coordinates manually from maps, or if possible generate these with the aid of GPS or GIS software packages.

### Sources

British Columbia MWLAP (2003), Alberta Environment (2006 a), Développement durable, Environnement et Parcs, Gouvernement du Québec (2007)

### At a glance

**1** Navigate to each pre-selected point in a regular pattern. Sample sites located in shallows by wading.

**2** Record at all sites, water depth, Secchi depth, turbidity and bottom light level (if equipment is available). Within the study area record water temperature or profiles at several shallow and deep sites.

**3** Record the species present at each sampling site based on observation from the boat. Use an underwater viewer and rake sampling to obtain supplementary information.

**4** Identify plants on-site or retain them for later identification. Place collected plants in sealable plastic bags along with a label providing all pertinent information. Record sample collections, a sample number, all pertinent site information, and GPS location in a note book or field sheet.

*properly  
preserve*

**5** Properly preserve in a plant press samples to be archived or included in reference collections.

Obtain semi-quantitative results by modifying the study design and field sampling procedure as follows:

**1** Conduct sampling at each sampling site in a consistent manner and level of effort. At each site, make the same number of rake drags/tosses and, if possible sample an equivalent area with each drag or toss.

**2** Determine and record the relative robustness of plant growth at each site. Include descriptors such as Dense, Moderate, Sparse and Trace.

**3** Identify the species present and estimate the relative proportion of each species for each rake sample. Record species

that are present in very small amounts, perhaps only as fragments, as ‘present’ or ‘trace’ only.

## 11.4 PROTOCOL FOR LINE INTERCEPT MACROPHYTE SURVEYS

### Overview

The Line Intercept method uses a system of transects that representatively encompass all aquatic macrophyte community types within a water body to derive a qualitative description of those communities. Use the survey data to identify and describe plant communities or bed types. Use a study area reconnaissance in combination with a number of representative survey transects to facilitate a reasonable qualitative description and delineation of bed types and distribution. The end products for a qualitative Line Intercept survey include a map showing the distribution of plant bed types plus a list of species for each plant bed type and the water body or study area as a whole. Transects are generally laid out perpendicular to the shore. Line Intercept surveys are most effective where plants are readily visible from a boat, generally less than 1-2 m of depth.

If the littoral zone extends to greater depths Line Intercept surveys may be conducted using a snorkeler or diver, although such surveys are more difficult to conduct. If divers are used, they should be familiar with *in-situ* identification of aquatic macrophytes.

### Sources

British Columbia MWLAP (2003), Alberta Environment (2006 a), Développement durable, Environnement et Parcs, Gouvernement du Québec (2007)

### Special safety concerns

Divers must be certified (e.g., PADI, NAUI, or equivalent) and familiar with accepted safe diving practices and any employer policy.

### At a glance

*identify all vegetated littoral areas*

#### Qualitative surveys

**1** Conduct a preliminary reconnaissance survey (e.g., Surface Inventory) to identify and delineate all vegetated littoral areas within the water body or study area. The number of transects required will vary from site to site and will be according to study design. Stratified sampling designs are usually suitable.

**2** Prepare a transect line marked at 1 m intervals with fluorescent flagging tape. Use of alternate colours at the 5 m and 10 m intervals simplifies tracking along the transect line. The transect line should be of a set length (e.g., 100 m), appropriate for the size of the water body or plant beds likely to be encountered. The line length may also equal the distance between end points in studies with permanent transects.

**3** Secure the transect line at both ends by attaching to poles or

to anchor lines.

**4** Conduct surveys by navigating the boat along a transect line and recording all species occurring along individual line segments. Plants are deemed present if they intersect the vertical plane between the transect line and the bottom.

**5** Wading is an option in very shallow near-shore waters. Use an underwater viewer in deeper or murkier water, or where the top canopy of plants obscures plants at lower levels. Use rake sampling to collect samples for observation or reference collection.

**6** Record water depth at each end of the transect line and at interval markers, record GPS waypoints, Secchi depth, turbidity, and bottom light level (if equipment is available) at each end of the transect line and at intervals along the line (e.g., at important transitions). Record water temperature or profiles at several shallow and deep sites within the study area.

*information  
to record*

**7** Identify plants on-site or retain them for identity verification at a later time. Place collected plants in sealable plastic bags along with a label providing all pertinent information. Record sample collections in a note book or on field sheets, along with a sample number, all pertinent site information, and GPS location.

**8** Properly preserve samples in a plant press. Samples will be archived and/or included in reference collections.

### **Semi-quantitative surveys**

**1** Select transect locations on a stratified-random basis, ensuring that all strata (i.e., bed types or geomorphically similar units) are equitably represented.

**2** Conducting semi-quantitative sampling at 1 m intervals is likely to be time consuming. Select larger intervals (e.g., 5 m or 10 m), or base sampling site selection on changes in bed type or a geomorphic characteristic(s) such as depth or substrate type.

**3** Conduct sampling at each sampling site in a consistent manner and with a consistent level of effort. Use the same number of rake drags or rake tosses and, if possible, sample an equivalent area with each drag or toss.

**4** Determine and record at each site the relative robustness of plant growth. Use descriptors such as Dense, Moderate, Sparse and Trace.

**5** Identify the species present and estimate the relative proportion of each species in the sample for each rake sample. Record species present in very small amounts, perhaps only as fragments, as 'present' or 'trace' only.

## 11.5 PROTOCOL FOR TRANSECT WITH QUADRAT MACROPHYTE SAMPLING

### Overview

Determining biomass is a quantitative assessment that requires considerably greater effort than qualitative assessment of aquatic macrophyte communities. Quantification of aquatic macrophytes is based on stratified-random sampling designs requiring at least a basic understanding of water body geomorphic conditions, the nature and distribution of plant community types. Biomass studies are usually impractical in large water bodies because of the effort involved and are typically limited to smaller ponds or discrete portions of lakes and rivers (e.g., bays or reaches).

### Sources

British Columbia MWLAP (2003), Alberta Environment (2006 a), Développement durable, Environnement et Parcs, Gouvernement du Québec (2007)

### At a glance

*consistency*

*dry to  
remove  
surface  
water*

- 1** Select transect locations on a stratified-random basis, ensuring that all strata (i.e., bed types or geomorphically similar units) are equitably represented.
- 2** Pre-select or field-select sampling sites provided that they conform to study design protocols.
- 3** Conduct sampling at each sampling site in a consistent manner and with a consistent level of effort. Determine the appropriate number of replicate samples collected at each site from the study design.
- 4** Drop or throw the quadrat in a random manner and allow it to sink to the bottom at each site.
- 5** Use a diver to harvest all the plants rooted within the quadrat. Cut plants at the water/substrate interface and place the entire plant in a mesh bag. If the roots are to be collected, they should be dug out of the substrate and rinsed before being placed in the bag.
- 6** Bring plants to the surface and transfer them to a plastic bag along with a label providing all pertinent information. Record sample collections in a notebook or on field sheets, along with the sample number, all pertinent site information, and GPS location.
- 7** Record water depth at each site as well as GPS waypoints, Secchi depth, turbidity and bottom light level (if equipment is available). Record water temperature or profile at several shallow and deep sites within the study area.
- 8** Sort plants from each sample by species as soon as convenient. Include whole plants and plant fragments, but exclude senescent plants.
- 9** Spin each species in a centrifuge dryer to remove all surface water. Weigh plants to determine the 'fresh' weight for each species within the sample. Record total weights for each species. Re-bag the plants for further analysis or discard them if no

longer needed.

**10** Retain representative samples for each species for verification of species identification. Record sample collections in a note book or on field sheets, along with a sample number, any pertinent site information, and the GPS location.

**11** Properly preserve in a plant press samples to be archived or included in reference collections. Express biomass, or standing stock, as *fresh weight of each species g/m<sup>2</sup>*, and *total fresh weight g/m<sup>2</sup>*, or as *dry weight g/m<sup>2</sup>*. Use the detailed procedures for determining fresh weight and dry weight from the following points.

**12** Place an individual sample into the centrifuge dryer (e.g., salad spinner) ensuring that any rocks, sticks, and detritus are removed. Centrifuge the sample for approximately one minute at a moderate speed (approximately one revolution per second). Spin samples until all the surface moisture has been removed. Remove and weigh on an electronic balance or with a spring scale in a plastic bag (subtract the bag weight). Record the weight.

**13** To use an oven-drying method, wash the sample using a sieve tray to remove rocks, debris, and invertebrates. Place each sample on a pre-weighed oven pan. Label it and place it in an oven at 105° C for 24 hours. After 24 hours, remove and weigh the sample on a balance (remember to subtract the pan weight). Record the weight.

*oven-drying  
method*

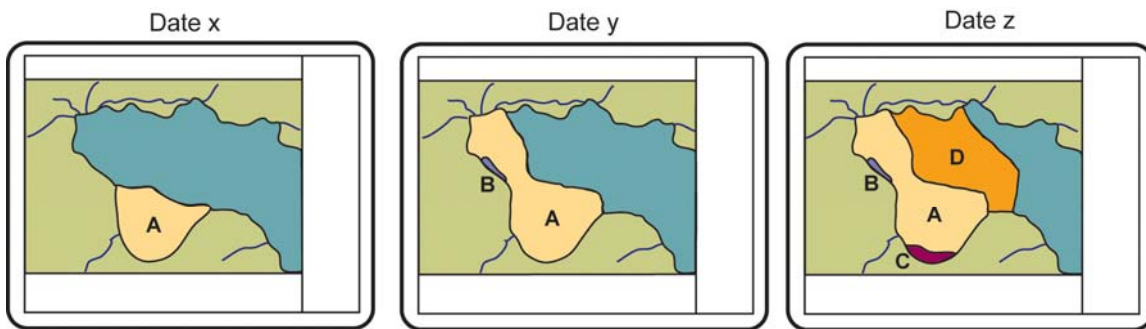

Figure 22. Example of use of aquatic macrophyte mapping through time  
(Source: Développement durable, Environnement et Parcs, Gouvernement du Québec (2008b))

## 11.6 PROTOCOL FOR SAMPLING MACROPHYTES IN RIVERS AND STREAMS

### Overview

The methods described in this section use techniques outlined for lakes and apply them to rivers and streams.

### Sources

Alberta Environment (2006 a), Développement durable, Environnement et Parcs, Gouvernement du Québec (2008 b), British Columbia MWLAP (2003).

### At a glance

*benchmark  
as reference*

#### Routine sampling in large rivers

**1** Establish a benchmark on shore to serve as a reference. Record UTM GPS coordinates for the benchmark. Use the same benchmarks if surveys are repeated. Measure out to the desired site or depth and record GPS coordinates. Take photographs to illustrate the sites and macrophyte growth.

**2** Note the species present, relative abundance (%) of each and growth robustness.

**3** Drop the quadrat in a random manner. Remove all rooted plants from within the quadrat, allow plants to drain then transfer to a labeled plastic bag.

**4** Take the following measurements at each point as required: depth, light readings (surface, sub-surface, mid-point, bottom), velocity measured when >1m depth at 0.2 and at 0.8 of depth, and when <1m at 0.6 of depth.

**5** Record water temperature and all pertinent sampling information (date and time of sampling, GPS location, sample numbers, photo reference numbers).

**6** When taking replicate or additional samples or when returning to the same site, move upstream to avoid sampling the same area twice in the same season.

**7** Follow the methods noted above for lakes when plant weights are required.

**8** Properly preserve in a plant press samples to be archived or included in reference collections.

#### Peak-growth sampling in large rivers

**1** Sample 10 random points at each site (5 right bank, 5 left bank) in the area of highest biomass (details may vary with study design).

*10 random  
points*

**2** Drop the quadrat in a random manner at each marked site. Note the species present and relative abundance (%) of each; and growth robustness and use descriptors of robustness as Dense, Moderate, Sparse and Trace. Take photographs to illustrate the sites and macrophyte growth.

**3** Collect plants rooted within each quadrat in separate pre-labeled bags.

**4** Take the following measurements at each point as required: depth, light readings (surface, sub-surface, mid-point, bottom), velocity measured when >1m depth at 0.2 and at 0.8 of depth, and when <1m at 0.6 of depth.

**5** Record water temperature and all pertinent sampling information (date and time of sampling, GPS location, sample numbers, photo reference numbers).

**6** Do weight determinations as outlined for lakes.

### **Transect sampling in small rivers**

**1** Select a representative 250 m reach of river.

**2** Select five transects at 50 m intervals. Measure total width at each transect. Divide total width by 11 to obtain 10 sampling points.

**3** At each sampling point, measure the depth. Using the quadrat, determine the first and second dominant substrates, macrophyte percent coverage and macrophyte algae percent coverage, according to the following:

#### **Substrate Categories:**

Silt and Sand < 2 mm

Fine Gravel 2-16 mm

Coarse Gravel 16-64 mm

Cobbles 64-256 mm

Boulders > 256 mm

#### **Percent Coverage Categories:**

Absent 0%

Sparse 1-30%

Moderate 30-60%

Dense 60-100%

**4** Determine relative cover for species across transect.

**5** Choose two sampling points at each transect for macrophyte collection using a random number table.

**6** Collect all macrophytes using a quadrat as described previously. If no macrophytes are present within the quadrat, record “0” in field notes, and select a third random number for macrophyte collection.

**7** Remove with 5% acetic acid prior to spinning (optional) if CaCO<sub>3</sub> is present.

**8** Spin macrophytes one minute or until all surface water has been removed.

**9** Determine weights as discussed for lakes.



## 11.7 PROTOCOL FOR MACROPHYTE TAXONOMY

### Overview

Collect the whole plant. Some species groups cannot be identified without mature fruits or flowers. Press large plants and mount on a 30 cm by 40 cm white card that is dimensionally stable when wetted. Use small screw cap vials (good collecting and preservation containers) for small plants like the duckweeds as they do not make suitable pressed and dried specimens.

### Sources

British Columbia MWLAP (2003)

### At a glance

#### Small floating species collection

- 1 Scoop a few individual plants into a pre-labeled vial.
- 2 Preserve the specimens in a solution of 70% ethanol, 25% water and 5% formalin.
- 3 Submit these specimens to a herbarium where they will be identified to species and stored for future reference.

#### Large emergent or rigid plants for taxonomic purposes

*proper storing*

- 1 Before placing the plants onto the card (cannot write on the card once wet), record field notes directly onto the card stock. Write the notes in pencil in the lower right hand corner of the card where it can later be covered by the permanent label.
- 2 Collect an entire specimen and store it until conditions are appropriate to mount. **Do not leave plants out in the sun even briefly as they will wither very quickly and become useless as specimens. Do not submerge emergent plants, but keep them in a bag with a little water in the bottom to maintain high humidity. Keep each species in its own bag. Samples from one site should be organized by bagging the individual bags from one site together in one large (garbage) bag.**
- 3 To mount each specimen, lay the plant on the card stock with the roots in the bottom left corner (fold over the top if it is too tall to fit).
- 4 Spread out leaves and flowers, turn some over so the bottoms can be seen, and try to make a neat and tidy specimen that covers the whole sheet. **For small plants, fill the sheet with more specimens from the same clump or clone to show as much variability as possible.**
- 5 Collect the seeds into small paper or cellophane pouches and attach these pouches to the finished herbarium sheet (for fruiting plants where the seeds may be shed on drying).
- 6 Place a piece of heavy blotting paper on top of the specimen to help dry the plant quickly after mounting the aquatic plant on the card stock.
- 7 Wrap the card stock, plant, and blotter in a newsprint folder. The newsprint should be 30 cm by 90 cm in size and folded in

half to form a folder in which the mounted plant is placed.

**8** Once several of these wrapped packages (each containing one card stock/specimen) have been accumulated, place them into a plant press with a piece of corrugated cardboard separating each package. The corrugations should run in the same direction so that air flow through the press is facilitated.

*dry within  
several days*

**9** Dry within several days to prevent fungal growth and minimize rotting of specimen. This will also preserve colours and shapes as much as possible. If in a laboratory or herbarium the same day, the plant presses may be dried in a proper plant drier or a forced draft oven at 40°C. In the field, use motel hot air registers, baseboard heaters, or hair dryers to move warm air through the corrugated cardboard. If the weather is dry, secure the plant press on the roof of the truck and allow air to blow through the corrugated cardboard as you drive from site to site. As the plants in the presses dry, it will be necessary to re-tighten the presses at least daily, to maintain the pressure and hold the plants flat.

**10** These specimens must be submitted to a herbarium where they will be identified to species and stored for future reference.

## 11.8 PROTOCOL OR MACROPHYTE TISSUE ANALYSIS

### Overview

Plant tissues may be collected for analyses of metals, pesticides, nutrients, plant products, for dry weight/wet weight ratios, or for other laboratory analyses. In all cases an entire, intact, voucher specimen of each species should be collected and filed in a herbarium as a record of what was analyzed.

### Sources

British Columbia MWLAP (2003).

### Special safety concerns

Always wear gloves when handling dry ice.

### At a glance

**1** Collect entire specimens, keep them submerged and covered until they can be processed (plants should never be allowed to desiccate).

**2** Place each specimen in individual airtight bags (e.g., Ziploc-type bag), tissue cups or glass bottles (for analysis of trace organics). Ensure specimen container is fully labeled. Ensure that the quantity of tissue and the container type are appropriate for the analysis that will be conducted.

**3** Place the sample container in the required cooler for shipping (some analyses need to be frozen; therefore, these samples will be placed in a cooler containing a sufficient quantity of dry ice).

## 12.0 PROTOCOL FOR BIOFILM SAMPLING

### 12.1 PROTOCOL FOR BIOFILM SAMPLING

#### Overview

Biofilm can be defined as the largely biotic community attached to rocks and cobbles of a stream or lake, largely made up of periphyton with associated invertebrates, zooplankton, and usually some abiotic material. This material is indicative of the productivity of a stream, and due to its integrative capacity (high organic carbon) can be used to measure the degree of organic contamination. Qualitative and quantitative sampling methods for biofilm exist. In rivers and streams, benthic algal communities typically account for most primary productivity. Benthic algal communities living on substrate surfaces are collectively referred to as periphyton. Sampling protocols in this section are concerned with the quantitative assessment of two kinds of periphyton; epilithic periphyton that are attached to the surfaces of rocks or other objects projecting above stream bottom, and epifaunal periphyton that are associated with sand. There are two main components to this type of sampling:

- location of the sampling points along a transect in the stream or river, and
- collection of periphyton from the substrata.

#### Sources

Environment Canada (1999), British Columbia MWLAP (2003), Alberta Environment (2006 a)

#### Special safety concerns

Don't attempt to lift rocks that are too heavy and don't enter water that may pose a threat to your safety. Watch your footing while returning to shore with the rock.

#### At a glance

##### Qualitative method

**1** Collect a number of submerged rocks from the river cross-section, and scrape the biofilm with a pre-cleaned (soap and water, acetone then hexane) knife or spatula into appropriate sample containers (disposable gloves should be worn).

*minimal to substantial effort*

**2** Collect appropriate ample volumes according to the study design. The amount of effort to collect 40 mL of material can vary from minimal (5-8 rocks) to substantial (20 rocks) depending upon the productivity of the stream, time of year, sunlight/shading, etc.

**3** Cool or freeze the sample (depending on the analytical requirement).

##### Quantitative method

*method to select rocks*

**1** Randomly select rocks to represent the variation in biofilm growth present at the sample location (i.e. they should not be chosen to maximize the sample size as in the case of the qualitative sample). A method to select rocks is to collect the

rock closest to the left foot after a predetermined number of paces are taken through the cross-section, and to continue this process until all necessary rocks are collected.

**2** Collect samples by placing a 5 cm diameter template over a randomly selected submerged rock, scribing around the circumference of the template, and scraping the biofilm material from within the scribed area into a sample container (usually a Whirl-pak bag). Repeat this process for three randomly selected rocks to produce a single sample, which is immersed in a small quantity of river water. Triplicate the process.

### Chlorophyll-a sampling

**1** Rocks to be sampled for periphyton should be sampled across a transect extending the width of the watercourse unless the river is too deep. This can either be an imaginary transect or a defined transect. A transect can be defined in smaller watercourses by:

- selecting a reference point in the middle of the site and driving a peg into the ground on one of the banks,
- attaching a tape measure to the peg and laying it out taut across the watercourse. Anchor the far end with the second peg (other bank), and
- divide the stream width into equally spaced intervals according to the number of rocks that are to be sampled (consult with the project manager).

*random  
rock  
selection*

**2** It is important to be random in the rock selection. Wade along the imaginary transect out from shore (a rope can be stretched across the river). Taking 2 steps select a rock (minimum size of 5 cm diameter) from approximately a 40 cm depth. Long arm gloves can be worn for this. For the defined transect, wade out to the first marked point and without looking, pick up a stone. If the stone is <5 cm diameter or a sandy, silty areas between cobbles is touched, then take the nearest stone that is > 5 cm diameter.

**3** All the stones may be collected at once or individually.. Place the stone(s) on a white tray with a small amount of stream water and return to the stream bank.

**4** If the river becomes too deep, head upstream repeating the above steps until all rocks are collected.

*thickness of  
algae*

**5** Orient each rock as it was in the river, and place the 4 cm<sup>2</sup> template over the area (chosen randomly) to be scraped. Only take a 2 cm<sup>2</sup> scrape per rock when the algae is really thick (instead of a 4 cm<sup>2</sup> scrape per rock). Remember to note this on the field sheets and labels. If the algae is extremely thick, a diagonal section of the template can be scraped, ensure the area is recorded.

**6** Using a scalpel, completely scrape off the algae found inside the appropriate template.

**7** The number of rocks and number of replicates collected will

*consult  
project  
manager*

depend on the river and project (consult the project manager). For example, scrapes from three rocks have generally been combined onto one filter. Three filters can be submitted per site. This should be pre-defined by the project manager prior to the sampling trip.

*transport to  
laboratory  
within 24  
hours*

**8** Alternatively, pour a small amount of de-ionized water over the freshly scraped algae (on the rock), this will form a slurry. Remove the slurry from the stone using a disposable pipette or a turkey baster, and transfer it to a 250 mL dark Nalgene bottle. Rinse the scalpel with de-ionized water into the Nalgene bottle to ensure transfer of any residual algae. When all the rocks in a sample are scraped, add 10-15 mg powdered  $MgCO_3$  to the bottle. Add double distilled/deionized water for an approximate total volume of 25 mL. Label the bottles with the total area of scrape contained in the sample, site, date, and "epilithic chloro". Store the Nalgene container at 4°C and transport to the laboratory within 24 hours.

**9** If the alternate method was not used on #8 above, place the algae from the scalpel directly onto a GF/C filter.

**10** Apply a light sprinkling of powdered  $MgCO_3$  to the material on the filter once all necessary rock scrapes for the replicate are completed.

**11** Wrap the filter in the aluminum foil in a way that the analyst can easily unwrap it to get at the filter and so that material doesn't come off on the foil.

**12** Label the wrapper with site, date, "epilithic chlorophyll", and the total area of scrape that it contains in  $cm^2$  (e.g., three rocks x 4  $cm^2$ =12  $cm^2$ ).

**13** Repeat the process for the other groups of rocks.

**14** Put the samples in a Whirl-pac or Ziploc bag and store on regular or dry ice (at -4°C).

**15** Place the samples in the laboratory freezer when you return from the field.

**16** Ship frozen samples to the laboratory every week for extraction.

### **Air-dried weight and species identification sampling**

**1** Follow the procedures outlined for chlorophyll-a for collection of samples. For example, pool scrapes from three rocks into a small jar for analysis of air-dried weight. Take species identification from the same number and sub-set of stones (e.g., pool scrapes from two into scintillation vial containing 10 mL of de-ionized/RO water).

**2** Add 2 mL of Lugol's solution to each vial.

**3** Line the scintillation vial cap with Parafilm prior to sealing the vials.

**4** Label each vial with site, location, date, area of scrape, and sampler's initials.

**5** Store vial in the dark.

### Sampling clean-looking but slimy rocks

**1** Follow the rock sampling instructions described above for the template sampling technique for chlorophyll-a (steps 1-4).

**2** Collect the number of rocks and number of replicates according to study design.

**3** Select a rock and affix the collar over an area of rock that was oriented upward in the stream.

**4** Use an artist's brush to physically rub the area of rock within the collar area, to dislodge the slime.

**5** Use a small amount of water to produce a slurry within the collar that can be transferred using a turkey baster or poured into a 1 L dark Nalgene bottle. Use a funnel to avoid spillage during pouring. Use a squirt bottle to rinse the slurry thoroughly from the collar, baster, and brush into the dark bottle. Try and use a minimal amount of water.

*filter within  
24 hours*

**6** Repeat this process for three rocks ensuring enough slurry is obtained. Shake some  $\text{MgCO}_3$  into the bottle (optional), store bottle (properly labeled with site, date, area sampled by collar multiplied by the number of rocks) in cooler until such time as sample can be filtered (not more than 24 hours later), set up the filter apparatus with GF-C filter, rinse filter, and proceed to filter the slurry through the apparatus. Rinse bottle adequately and filter to ensure all slurry is obtained. Cover the filter with powdered  $\text{MgCO}_3$  (optional), fold the filter in quarters, place in aluminum foil, and label with date, location, site number, total area of rock sampled, and sampler's initials.

**7** If too much slurry is obtained, a sub-sampling procedure may be used by mixing the slurry in a shallow graduated cylinder, and then draw up 10 mL of well-mixed slurry into the syringe (5 mL if the slurry is extremely thick).

**8** Filter the slurry through a GF/C filter. Rinse the syringe with a small amount of distilled water and filter this through the same filter. Cover the filter with powdered  $\text{MgCO}_3$  (optional), fold the filter in quarters, place in aluminum foil, and label with date, location, site number, total volume of slurry (using a graduated cylinder), volume of slurry filtered, and sampler's initials.

**9** Put samples on ice, or freeze with dry ice and deliver to the laboratory.



Photo 23 (left). Example of flexible plastic disc (Source: Alberta Environment (2006))

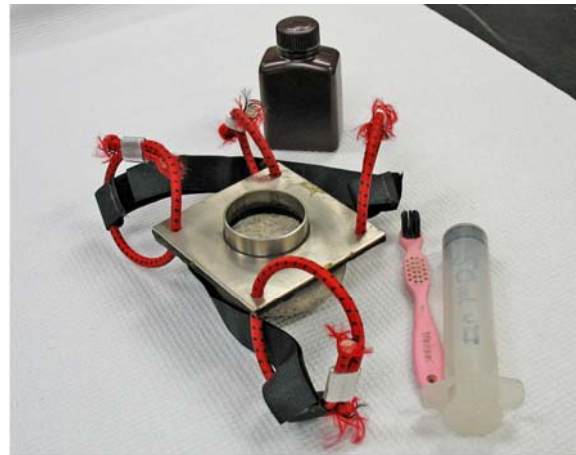

Photo 24 (right). Epicollar (Source: Alberta Environment (2006))



## 12.2 PROTOCOL FOR BIOFILM SAMPLING – SAND-CORING METHOD

### Overview

The sand coring method is used to quantitatively sample episammic benthic algae for chlorophyll-a or biomass determination. Some watercourses or sections of watercourses have sandy or silt substrates, these environments support communities of episammic algae. The template method is not appropriate for these soft substrates because algae are not attached to a defined surface: rather the algae are intermixed with the upper sediment layers. Coring techniques are far more effective to quantitatively sample algae from the upper layers of soft substrates.

### Sources

Environment Canada (1999), British Columbia MWLAP (2003), Alberta Environment (2006 a)

### At a glance

- 1** Place a clean Plexiglas liner in the barrel of the corer until the o-ring fits snugly.
- 2** Push the corer into the substrate and affix a rubber stopper to top of the tube.
- 3** Lift up the corer, but before it breaks the water surface place a cap on the bottom of the liner.
- 4** Remove the liner from corer and place a cap on top of it.
- 5** Remove the bottom cap and quickly place the liner on the core extruder and remove top cap.
- 6** Carefully push the liner down; this will dispel the overlying water.
- 7** Place the core slicer on top of the liner and push the core up into the slicer until the required depth of core is obtained.
- 8** Slice off the core and transfer it to a glass filtering apparatus equipped with a GF/C filter.
- 9** Gently (7 psi or 48 kPa) vacuum the core until dry.
- 10** Add 2 mL of saturated  $MgCO_3$  per core (optional) and vacuum to remove water.
- 11** Carefully place the filter and core material in a 300 mL Nalgene container.
- 12** Rinse (with acetone) any remaining material on the funnel into the Nalgene container. Add approximately 25 mL of acetone for each core.
- 13** Shake the core/filter/acetone mixture for 1 minute.
- 14** Label the Nalgene container and field sheet with the date, site, depth of water, depth of core, number of cores, volume of acetone used, and sampler's initials.
- 15** Cool to 4°C and transport to laboratory.

## 13.0 PROTOCOL FOR PHYTOPLANKTON SAMPLING

### Overview

Phytoplankton collection in the open water of a lake consists of surface and/or deep grab sampling. A Van Dorn bottle is the most common tool for collecting the deep samples for enumeration. In specific situations a net may be used as well. Care must be taken with net collection, numerous species can pass through even the smallest mesh sizes, colonies can be disrupted by the net, and fragile species may burst from excessive pressure.

### Sources

British Columbia MWLAP (2003) , EMAN (Undated a)

### At a glance

#### Qualitative sampling

- 1** Use a 10- $\mu$ m Nitex® mesh or similar phytoplankton net that is fitted with a stopcock at the lower end to allow opening and closing. The mouth of the net has a canvas collar fitted with a metal bridle that attaches to the sampling line.
- 2** Lower the net to a given depth, allow it to settle for 15 to 30 seconds and then pull it slowly to the surface. Pulling the net too fast will cause a bow wave and the net will be less efficient.
- 3** Position the mouth of the stopcock into a sample-collecting bottle and then drain the sample. Repeat three to four times if necessary.
- 4** Qualitative net sampling will yield presence/absence information and can aid in the identification of rare species but is not appropriate for accurate counting or biomass estimates.

#### Quantitative sampling

- 1 Surface Samples:** Anchor the boat at the designated sample site. Alternately, if the water is too deep or a buoy is not present, the person in the stern will have to maintain position while the person in the bow takes the samples.
- 2** Obtain a labeled, 1L sample bottle and remove the lid without touching the inner surface of either the bottle or lid.
- 3** Reach out an arm length from the boat to take the sample. Ensure that the person in the stern is providing counterbalance (working over the opposite side of the boat).
- 4** Sink the bottle under the surface and move it slowly towards the current (the direction the boat is facing) until the bottle is entirely full. Standard sampling depths for “surface” water samples are 0.1 m and 0.5 m.
- 5** Preserve the sample with 3 mL of Lugol’s solution (3-4 mL per 1 litre of sample). A general guideline is that there be sufficient Lugol’s added to adjust the color of the sample to resemble weak tea.
- 6 Samples at Depth:** Open the Van Dorn sampler by raising the end seals.

- 7** Set the trigger mechanism.
- 8** Lower the sampler to the desired depth (epilimnion, hypolimnion or thermocline: the location of which should have been determined by prior DO/temperature profile data collection. Ensure that the dead end of the rope is tied to the boat.
- 9** Send the messenger down to “trip” the mechanism that closes the end seals.
- 10** Retrieve the sampler to the surface.
- 11** Transfer the water sample from the Van Dorn bottle to labeled, 1 L sample containers via the drain valve.
- 12** Preserve the sample with 3 mL of Lugol’s solution (3-4 mL per one litre of sample).
- 13** Recap the bottle and place in the cooler.

## Other Sources

Nova Scotia Environment and Labour (1996)

## 14.0 PROTOCOL FOR SAMPLING MUSSELS FOR METALS AND TRACE ORGANICS

### Overview

This protocol details methodology to collect indigenous species of mussels. If possible have these shipped to a laboratory for analyses or for transplanting in other areas for a specific time period.

### Sources

Gulf of Maine Council (1992), Gulf of Maine Council (1992)

### At a glance

#### Collecting indigenous mussels

- 1** Collect mussels from a sub-tidal (below the low water line) or low intertidal segment of the shoreline.
- 2** Ensure that at least one collection is timed to avoid unusual sediment re-suspension by storms or stormwater runoff.
- 3** Collect mussels in replicate in order to examine within site variation.
- 4** Collect mussels from each of four discrete areas of the sub-tidal zone (total n=200). The replicates areas should be within a 50 m section of the shore so that they represent one zone of water quality and environmental conditions.
- 50-60 mm* **5** Ensure that all indigenous mussels are of a standard 50 to 60 mm shell length.
- 6** Wash all mussels to remove soft external growth, sediment, and debris using clean seawater from the collection site. Avoid damaging the byssus as this affects growth and survival of the mussel.
- 7** Place the mussels on a bed of seaweed or in clean containers (e.g. gallon size wide mouth glass jars) with cool packs, and transport them to the laboratory.
- 8** Use these mussels for analysis or for subsequent transplanting to other sites.

#### Transplanting mussels

- 1** Use four cages, each containing 50 mussels, at each site when transplanting mussels for a 60-day deployment period.
- 2** Mark 15 of the 50 mussels to be placed in each cage on the left posterior side of the shell using a high speed engraving tool ("Dremel"-type). Take care to mark the shell deep enough to be able to read the numbers on retrieval but not so deep as to penetrate the shell and injure or kill the animal.
- 3** Measure each numbered mussel and record the shell length to the nearest 0.1 mm using a vernier or digital caliper so that growth over the deployment period can be determined.
- 4** Place each group of mussels into separate clean containers after marking and sorting the mussels into replicate groups and hold them in a refrigerator (or a cooler with freeze packs) until deployed into their cages (23 mm x 23 mm x 23 mm

polypropylene moulded baskets). Ensure that mussels are not held out of water for more than two days.

**5** Secure the lids with nylon "pull ties". Fasten the cages together with the pull ties and run the mooring line through the cages. Attach any instrumentation, such as the recording thermometers to the outside of the cage

**6** Suspend the cages in the water column by means of a subsurface float (e.g. an 8" Styrofoam trawl float). Arrange the mooring gear so that cages are suspended 1 m off the bottom but at a depth that ensures that the cages are underwater at low tide. In areas with a strong current, polypropylene encased steel cable can be used for mooring lines. In addition, either 1 or 2 concrete blocks may be used as inexpensive moorings.

*use  
adequate  
mooring in  
strong  
currents*

**7** Take precautions to prevent chafing, which can sever the mooring line from the blocks. If the current is strong, use multiple moorings holding fewer cages.

**8** Check cages every 2-4 weeks depending on the site conditions. Clean cages of all fouling that would interfere with sea water exchange. Inspect all lines, fastenings and mooring blocks for chafing. Where required re-position, repair and adjust cages if necessary.

**9** Retrieve mussels after the period established in the study design (typically 60 days). Clean all mussels from each of the four cages of external debris and rinse them in seawater from the site. Place the mussels from each cage in clean, clearly labeled glass containers with aluminum foil over the mouth of the jar for transport to the laboratory in coolers with freeze packs.

## 15.0 PROTOCOL FOR SAMPLING ZOOPLANKTON

### Overview

Zooplankton are small invertebrates that float freely in the water column of lakes and oceans. Zooplankton are important as both prey and consumers in the aquatic food web. Zooplankton also act as bio-monitors because they are also highly sensitive to environmental change or disturbance in lakes. Zooplankton are sampled to provide quantitative estimates of community composition, densities and/or biomass within lakes. Zooplankton are sampled with a net (Figure 23) that has a specific mesh size (ranging from as small as 64  $\mu\text{m}$  to as large as 256  $\mu\text{m}$ ). Zooplankton densities and species composition show spatial variability both horizontally and vertically in lakes.

### Sources

Alberta Environment (2006 a), B. C. WLAP (2003), Environment Canada (1999)

### Special safety concerns

Formalin is used as a preservative and is identified as a suspected carcinogen. Formalin should be used with extreme care and the MSDS should be read.

### At a glance

*avoid  
sediments  
and  
macrophytes*

- 1** Soak the body of the zooplankton net in lake water prior to use (2 minutes).
- 2** Rinse the net with lake water to dislodge any attached material prior to sampling.
- 3** Attach the zooplankton bucket: make sure the plug is in place.
- 4** Fill the Nalgene squirt bottle with lake water that has been filtered through the net mesh.
- 5** Lower the net to the euphotic zone depth making sure it stays in a vertical position. Raise the net vertically at a continuous rate of 0.5 m/s to minimize avoidance of the net by fast-swimming zooplankton.
- 6** Avoid sampling near sediments and macrophytes because non-planktonic species of Rotifera and Crustacea inhabit these substrates and would contaminate the sample.
- 7** At the surface, rinse down the outer sides of the net, repeat two or three times with lake water. Do not splash rinse water into the net opening, or let the net drop below the surface.
- 8** Separate the bucket from the net, place the lower end of the bucket into an open sample jar, then remove the plug and drain the zooplankton and water into the jar. Rinse the bucket contents into the sample jar with the squeeze bottle previously filled with filtered net water.
- 9** Preserve zooplankton samples in either 95% ethanol or 5% formaldehyde. Formaldehyde is preferred because counting samples preserved in ethanol is difficult because of the convection currents caused by rapid evaporative losses. The

*formaldehyde  
preservation*

following approaches can be used to reduce distortion due to formalin preservation: (a) add 40 g/L of sucrose to formaldehyde solutions; (b) maintain samples at low temperature (6°C); and (c) narcotize with carbonated water or methanol prior to preserving in a formaldehyde-sugar solution.

**10** Rinse the net and bucket with lake water between sites.

**11** Record sampling location (GPS coordinates), site, date, time, samplers ID, number of hauls, and depth of haul on the jar and field sheets/book. Note the mesh size and dimensions, the fixative used, and the prevailing weather conditions in the field sheets/book. Note and record ice depth in the winter.

**12** Put a few drops of glycerin into sample when back at the laboratory, before storage of sample to help to prevent the animals from sticking together.

**Other  
Sources**

EMAN Undated (d)

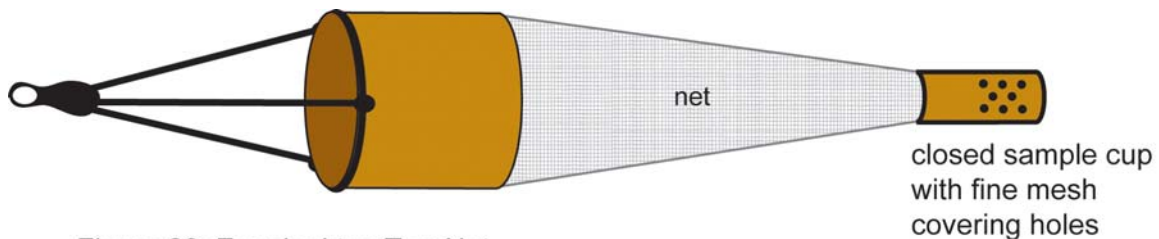
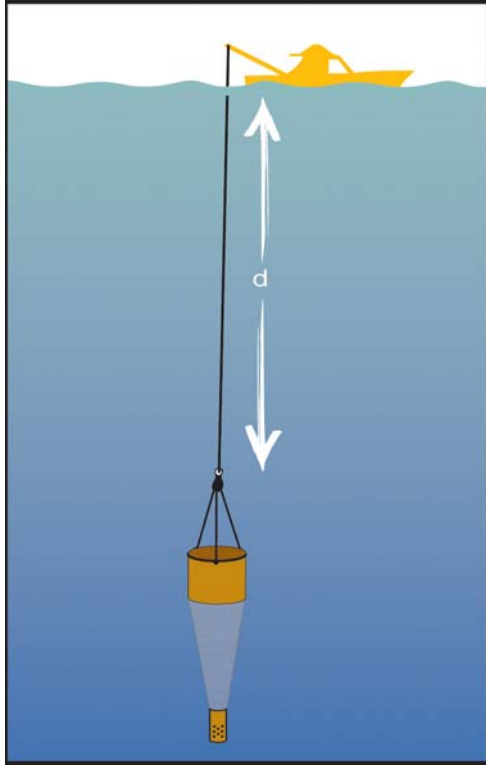

Figure 23: Zooplankton Tow Net



**Volume of Water through a Zooplankton Tow =  $\pi * r^2 * d$**   
**Where: r = radius of net mouth**  
**D = depth**  
 **$\pi = 3.1416$**

Figure 24. Tow volume calculation



## GLOSSARY OF TERMS

**Acid Rinse** – A process whereby equipment is rinsed thoroughly with acid, ensuring that the acid makes contact with all surfaces likely to be in contact with the sample.

**Acid Soak** – A process whereby equipment is soaked for a period of time (often 12-24 hours, though can be as short as 30 minutes).

**Automated sampling** – a system that allows samples and/or measurements to be collected at pre-determined intervals and/or times without humans physically collecting the actual measurements.

**Benthos** - the organisms which live on, in, or near the seabed.

**Biofilm** - the largely biotic community attached to rocks and cobbles of a stream or lake, largely made up of periphyton with associated invertebrates, zooplankton, and usually some abiotic material.

**Bottle blanks** - measure contamination from improper cleaning of bottles.

**CALA** - Canadian Association for Laboratory Accreditation.

**Chain of custody** - a form used if the project is being carried out for a legal reason (e.g., compliance monitoring). This form guarantees that the sample has not been tampered with, that only authorized personnel have handled the samples, and that appropriate field sampling techniques for the program are used. All transfers of samples are noted on the form. Transfer procedures are also described to make sure samples are properly protected and preserved. Any changes in sampling or sample storage are noted on the chain of custody form.

**Composite sample** – a sample composed of several sub-samples typically collected at different temporal or spatial intervals.

**Deployment tubes** – tubes used in automated stations to protect sensors and cables from environmental stressors or human vandalism.

**Discrete or grab sample** – a sample taken at one point in time.

**Drift net sampler** – a sampler used to collect the emerging or drifting invertebrate stages.

**Drum roller** – a sampler which rotates and collects the top surface layer of the water.

**Ekman grab samplers**- sediment samplers that are most efficient in softer sediments.

**Euphotic or photic zone** - is the depth of the water in a lake or ocean, that is exposed to sufficient sunlight for photosynthesis to occur. The depth of the photic zone can be greatly affected by seasonal turbidity.

**Field blank samples** - measure contamination from bottles, collection methods, the atmosphere, and from preservatives. Field Blanks are prepared in the same manner as a trip blank and makes the journey as a trip blank; however, the field blank sample is opened and the collection process is mimicked.

**Field quality assurance program** - a systematic process, involving laboratory and data recording quality assurance processes/procedures. Field Quality Assurance provides a specified degree of confidence in the data collected for an environmental survey.

**Field replicates** - provide precision of field plus laboratory plus environmental heterogeneity.

**Filtration** – passing a sample through a pre-determined filter size. The filter can be paper or glass.

**Filtration blanks** - used to measure contamination from the filters and the filtration apparatus.

**Grab or discrete sample** – a sample taken at one point in time.

**Hess cylinder sampler** - one of the most commonly used benthic invertebrate samplers to sample erosional substrates in streams and rivers. This sampler is suited to a range of erosional substrate types such as gravel, cobble, small boulders, and sand.

**JSA** - job safety analysis identifies what work will take place, lists all of the potential hazards that could be encountered during the work, and details the measures necessary to avoid or mitigate the hazard.

**Kemmerer sampler** – a sampler used for lake sampling > 1 m in depth.

**Meiofauna** - defined as microscopic animals that pass through 500 µm screen but are retained by a 64 µm screen.

**Microbial source tracking** - a specialized area of determining the source of bacteriological contamination.

**MSDS** - material safety data sheets provide detailed hazard-precautionary and first aid treatment information for controlled substances. MSDS provide important information on the hazardous ingredients, physical data, fire and explosion hazard, reactivity data, health effects, preventative measures, first aid measures and preparation information.

**Multi-sampler** – a sampler that collects several sample containers at one time thereby ensuring that the same mass of water is collected for all analyses at the same time.

**Neill cylinder sampler** - one of the most commonly used benthic invertebrate samplers to sample erosional substrates in streams and rivers. This sampler is suited to a range of erosional substrate types such as gravel, cobble, small boulders, and sand.

**Package tests** – a large number of variables measured in a laboratory for a fixed price, instead of having analyses completed for individual variables.

**PAR** – photosynthetically-active radiation is a slightly narrower band of radiation (400 – 700 nm) than visible light, and is the area of the spectrum used by plants. The measurement of PAR profiles is undertaken to measure PAR attenuation with water depth.

**Parafilm** - self-sealing, moldable and flexible film.

**PFD** - personal flotation device that allows you to float when in the water.

**Ponar grab samplers** – sediment samplers that are most efficient at sampling harder sediments.

**Proficiency testing** - the use of inter-laboratory comparisons to determine the performance of individual laboratories for specific tests or measurements.

**Proficiency Testing (PT) Program** - targets high volume testing in the disciplines of inorganic chemistry, organic chemistry, toxicology, occupational health and microbiology for the following matrices: water, waste oil, soil/sediment, air collection media (e.g. quartz and cellulose acetate filters, and charcoal tubes) and asbestos testing.

**Replicate sample** – a sample collected at the same time as the original sample to determine the precision (how close the results are to each other) of tests.

**Secchi disc** – a flat plate with four quadrants painted alternating white and black used in the field to measure the transparency of the water column. The measurement is made by allowing the disc to drop to the point where it is no longer visible, then raising the disc until it is visible and averaging the two depths.

**Sensors** - electrical, electrochemical, or optical in nature and respond to changing water conditions with an output signal that is processed and displayed or recorded.

**SOD** (Sediment oxygen demand) - a measure of the oxygen consumed by biochemical decomposition of organic matter in stream or lake deposits.

**Sonde** – multiple sensors in one configuration.

**Split samples** - aliquots taken from the same container and assumed to be identical. These samples can be sent to two or more laboratories for separate analysis and the results can be used to determine inter-laboratory variability of the different laboratories or the consistency of results within one laboratory.

**Standard reference materials or samples** - (where the actual value has been certified independently) are used to determine if the results are accurate (close to the true value).

**TDG** - Transportation of Dangerous Goods.

**Surber sampler** - used to collect invertebrate samples for depths less than 30 cm.

**Travelling-Kick-and-Sweep** - the standard sampling method typically applied by wading along transects through the habitat of interest, kicking the substrate to dislodge benthos, and collecting dislodged benthos by “sweeping” a hand-held net through the water.

**Trip blanks** – these bottles measure volatile compounds, they are usually prepared in the laboratory and simply travel with the required sample bottles. The trip blanks are placed along side the required sample bottles for the duration of the sample period and return to the laboratory without ever being opened.

**v/v** – volume to volume used in reference to the amount of acid in solution.

**Van Dorn sampler** – a sampler used for lake sampling sites > 2 m in depth.

**WHMIS** - Workplace Hazardous Materials Information System ensures that all controlled products are labeled. This ensures that workers can identify all products, the dangers associated with products and any necessary safety precautions.

## REFERENCES

- Alberta Environment. March 2006 (a). *Aquatic Ecosystems Field Sampling Protocols*.
- Alberta Environment. July 2006 (b). *Guidelines for Quality Assurance and Quality Control in Surface Waters Quality Programs in Alberta*.
- B.C. Ministry of Environment. 1994. *Resources Inventory Standards Committee*
- B.C. Ministry of Environment. 2006. *Continuous Water-Quality Sampling Programs: Operating Procedures*. G. A. Butcher and L. A. Gregory
- B.C. Ministry of Environment. 1994. *Resources Inventory Standards Committee*
- (BCWLAP) B.C. Ministry of Water, Land and Air Protection. Undated. *A Preliminary Survey of Surface Microlayer Contaminants in Burrard Inlet, Vancouver, B.C. Canada 2001 Update*.
- (BCWLAP) B.C. Ministry of Water, Land and Air Protection. 2003. *British Columbia Field Sampling Manual for Continuous monitoring and Collection of Air, Air-Emission, Water, Wastewater, Soil, Sediment and Biological Samples*.
- Canadian Council of Ministers of the Environment (CCME). 1999. *Canadian Environmental Quality Guidelines*.
- Canadian Food Inspection Agency, Environment Canada, and Fisheries and Oceans. March 21, 2008. *Canadian Shellfish Sanitation Program Manual of Operations*.
- Développement durable, Environnement et Parcs, Gouvernement du Québec. 2006. *Guide d'identification des principaux macroinvertébrés benthiques d'eau douce, Québec, Surveillance volontaire des cours d'eau peu profonds*.
- Développement durable, Environnement et Parcs, Gouvernement du Québec. 2007. *Guide d'identification des fleurs d'eau de cyanobactéries, Comment les distinguer des végétaux observés dans nos lacs et nos rivières. 2<sup>e</sup> édition*. S. Blais
- Développement durable, Environnement et Parcs, Gouvernement du Québec. 2007 (a). *Protocole de mesure de la transparence de l'eau, Protocole élaboré dans le cadre de la surveillance volontaire des lacs*.
- Développement durable, Environnement et Parcs, Gouvernement du Québec. 2008 (a). *Guide de surveillance biologique basée sur les macroinvertébrés benthiques d'eau douce du Québec, Cours d'eau peu profonds à substrat grossier*. Moisan, J., and L. Pelletier
- Développement durable, Environnement et Parcs, Gouvernement du Québec. Juillet 2008 (b). *Protocole de suivi visuel d'une fleur d'eau d'algues bleu-vert, Protocole expérimental élaboré dans le cadre de la surveillance volontaire des lacs*.

- Développement durable, Environnement et Parcs, Gouvernement du Québec. 2008 (c). ***Protocole de fabrication d'un aquascope maison.***
- Eaton, A.D., L.S. Clesceri, E.W. Rice, A.E. Greenberg. 2005. ***Standard methods for the examination of water and wastewater, 21<sup>st</sup> edition.*** Co-Published by American Public Health Association, American Water Works Association, and Water Environment Federation. Washington, D.C.
- Ecological Monitoring and Assessment Network (EMAN). Undated (a). ***Protocols for Measuring Biodiversity: Phytoplankton in Freshwater.*** D. L. Findlay and H. J. King
- Ecological Monitoring and Assessment Network (EMAN). Undated (b). ***Protocols for Measuring Biodiversity: Parasites of Fishes in Freshwater.*** David L. Marcogliese and Parasitology Module Steering Committee
- Ecological Monitoring and Assessment Network (EMAN). Undated (c). ***Protocols for Measuring Biodiversity: Benthic Macroinvertebrates in Freshwater.*** D. M. Rosenberg, I. J. Davies, D. G. Cobb, and A. P. Wiens
- Ecological Monitoring and Assessment Network (EMAN). Undated (d). ***Protocols for Measuring Biodiversity: Zooplankton in Freshwater.*** Michael Paterson
- Ecological Monitoring and Assessment Network (EMAN). 2003. ***EMAN Monitoring Protocols and Standards, Ice Phenology.***
- Ecological Monitoring and Assessment Network (EMAN-North). 2005. ***Northern Waters: A Guide to Designing and Conducting Water Quality Monitoring in Northern Canada.***
- Environment Canada. Undated (a). ***Wolfe Island Field Site Sampling Protocol.*** Melanie Neilson.
- Environment Canada. Undated (b). ***Methods Manual II: Lake Invertebrate Sampling for Reference condition Data Bases.*** Trevor B Reynoldson,, Craig Logan, Tim Pascoe, and Sherri P. Thompson
- Environment Canada. 1998. ***Field Measurement of pH.*** FS012U00.
- Environment Canada. March 23, 1999 Draft. ***Field Procedures for Aquatic Quality Sampling.*** L. A. Mottle and R. W. Crosley
- Environment Canada. February 1, 2001. ***Sampling from Boats.*** FS3.Ver2.
- Environment Canada. April 15, 2002 (a). ***Procedures for Marine Water Quality Sampling. For submission to the Environment Canada Laboratory.***

- Environment Canada. December 27, 2002 (b). *Field Sampling – Filling in Sample Data Card*. FS17.Ver2.
- Environment Canada. June 23, 2003 (a). *Sampling through Ice – Field Blank Processing and Sample Collection*. FS4.Ver2.
- Environment Canada. June 23, 2003 (b). *Collection of Field Blanks and QA (Replicate) Samples Collection*. FS29.Ver2.
- Environment Canada. June 23, 2003 (c). *Sample Collection with Multiple Sampler*. FS5.Ver2.
- Environment Canada. June 20, 2003 (d). *Water Quality Sample Preservation for Cyanide Analyses*. FS23.Ver2.
- Environment Canada. June 20, 2003 (e). *Field Sampling – Air Temperature*. FS9.Ver2.
- Environment Canada. June 20, 2003 (f). *Field Sampling – Water Temperature*. FS10.Ver2.
- Environment Canada. June 20, 2003 (g). *Field Sampling – Sampling from Shore or by Wading*. FS2.Ver2.
- Environment Canada. 2005 (a). *Safe Work Procedure. Shore or In-Stream Sampling*.
- Environment Canada. 2005 (b). *Safe Work Procedure. Sampling from Bridges*.
- Environment Canada. 2009. *Great Lakes Surveillance Program Field Methods Manual*. Alice Dove, Serge L'Italien and David Gilroy.
- Environment Canada, Ecosystem Health Division, Ontario Region, Environmental Conservation Branch. 2006 (a). *Sediment Quality in Canadian Lake Huron Tributaries: A Screening-Level Survey*. D. A. Burniston, J. Kraft, Sean Backus and A. Dove. Report No. ECB/EHD-OR/06-01/I
- Environment Canada. 2006 (b). *Standard Operating Procedure for the Collection of Water and Suspended Sediment Samples at the Niagara River monitoring Stations (Fort Erie and Niagara-on-the-Lake) Ontario Water Quality monitoring and Surveillance Office WQMS*. SOP 06-6001. B. Harrison and P. Klawunn
- Environment Canada. April 2007. *CABIN Field Manual for Streams*. Reynoldson, T. B., C. Logan, T. Pascoe, S. Thompson, S. Sylvestre, C. Mackinlay, and H. McDermott
- Environment Canada. June 2008 Draft. *Standard Operating Procedure for the collection of Water Samples in Support of the Fish Monitoring and Surveillance Program*. Water Quality Monitoring and Surveillance Division

- Environment Canada and B.C. Ministry of Water, Land and Air Protection. July 2005  
 (a). Canada-British Columbia Water Quality Monitoring Agreement. ***Protocol for the Initiation, Maintenance, Suspension or Re-Introduction of Variables and Monitoring Stations.***
- Environment Canada and B.C. Ministry of Water, Land and Air Protection. July 2005  
 (b). Canada-British Columbia Water Quality Monitoring Agreement. ***Sampling Protocol - Monitoring Frequency***
- Environment Canada and B.C. Ministry of Water, Land and Air Protection. October 2005 (c). Canada-British Columbia Water Quality Monitoring Agreement. ***Water Quality Sampling Procedures, Safety and Quality Assurance.***
- Federal Interagency Sedimentation Project. 1965. ***Operating instructions suspended sediment hand sampler, US DH-48.*** May 1965
- (GOMC) Gulf of Maine Council on the Marine Environment, Monitoring Committee. 1992. Second Edition ***Gulfwatch Project Standard Procedures for Field Sampling, Measurement and Sample Preparation. Gulfwatch Pilot Project Period 1991 - 1992***
- (GOMC) Gulf of Maine Council on the Marine Environment, Monitoring Committee. August 1997. ***Gulfwatch Project Standard Procedures: Field and Laboratory***
- (ISO) International Standards Organization. 1987. ***Water Quality Sampling – Part 4: Guidance on Sampling from Lakes, Natural and Manmade. ISO 5667-4:1987(E).***
- (ISO) International Standards Organization. 1998. ***Water Quality Sampling – Part 14: Guidance on Quality Assurance of Environmental Water Sampling and Handling. ISO 5667-14:1998(E).***
- (ISO) International Standards Organization. 2003(a). ***Water Quality– Selection and Application of Ready-to-Use Test Kit Methods in Water Analysis. ISO 17381-2003(E).***
- (ISO) International Standards Organization. 2003(b). ***Water Quality– On-line Sensors/Analysing Equipment for Water – Specifications and Performance Tests. ISO 15839:2003(E).***
- (ISO) International Standards Organization. 2008(a) Draft. ***Water Quality Sampling – Part 6: Guidance on Sampling in Rivers and Streams. ISO 5667-6:2005(E).***
- (ISO) International Standards Organization. 2008 (b) Draft. ***Water Quality Sampling – Part 23: Determination of Priority Pollutants in Surface Water using Passive Sampling. ISO/TC 147/SC 6 N***
- (ISO) International Standards Organization. 2008 (c) Draft. ***Water Quality Sampling – Part 3: Preservation and Handling of Water Samples. ISO 5667-3.***



- Ministère de l'Environnement, Gouvernement du Québec. Octobre 2000. *Suivi de la qualité de l'eau des rivières et petits cours d'eau*. Serge Hébert et Stéphane Legare
- Ministère de l'Environnement, Gouvernement du Québec. (2004). *Programme de surveillance des substances toxiques contenues dans les chairs de poissons de pêche sportive en eau douce, Protocole d'échantillonnage*. Roger Audet
- NEG/ECP Committee on the Environment, Mercury Task Force, Fish Tissue Sub-group. August 2001. *Fish Tissue Testing and Analysis Practices in the New England States and Eastern Canadian Provinces*.
- New Brunswick Department of Environment and Local Government. July 2000. *Volunteer's Guide to Water Quality Monitoring. Version T2000-1*.
- Newfoundland Department of Environment and Labour. December 1999. *Sampling Manual (Water, Sediment, and Biological Sampling)*. Canada-Newfoundland Water Quality Monitoring Agreement
- Nova Scotia Department of Environment and Labour. Undated. *Automated Surface Water Quality Monitoring Network (Heritage River/Protected Area Program)*. D. Taylor as recorded by EcoCreate Solutions for CCME 2008.
- Nova Scotia Department of Environment and Labour. 1996. *DOF/DOE Joint Lake Water Quality Monitoring Program – Summer 1996 Field Protocol for Water Sampling*. D. Taylor
- Ontario Ministry of the Environment. December 2005. *Ontario Benthos Biomonitoring Network Protocol Manual*. C. Jones, K. M. Somers, B. Craig, and T. B. Reynoldson
- Ontario Ministry of the Environment. Memorandum. August 1, 2006. *Water Sample Collection and Submission Protocols for Partners in the Provincial Water Quality Monitoring Network*. Aaron Todd.
- Parks Canada. March 2007. *Monitoring and Reporting Ecological Integrity in Canada's National Parks. Volume 2: A Park-Level Guide to Establishing EI Monitoring*.
- Personal Communication. Mr. Mark Sekela to ECOCREATE.
- Prince Edward Island. Undated. *PEI Standard Operating Procedure for DEEF – Watershed Management YSI 55 and 85 Field Meters*.
- Province of Saskatchewan. Undated. *Surface Water Quality Monitoring Sampling Methods*.
- Service des eaux municipales; Ministère du Développement durable, de l'Environnement et des Parcs. Gouvernement du Québec. Mars 2005. *Guide d'identification des fleurs d'eau de cyanobactéries. Comment les distinguer des végétaux observés dans nos lacs et nos rivières*.

United States Environmental Protection Agency. June 2005. *Microbial Source Tracking Guide Document*. EPA/600/R-05/064

United States Geological Survey (USGS). 2005. *A guide to the proper selection and use of federally approved sediment and water-quality samplers. Open-file report 2005-1087*. U.S. Department of the Interior and U.S. Geological Survey.

United States Geological Survey (USGS). 2006. *Guidelines and standard procedures for continuous water-quality monitors: station operation, record computation, and data reporting. Techniques and Methods 1-D3*. U.S. Department of the Interior and U.S. Geological Survey.