



SPALDING

TRUE TO THE GAME™



SPALDING

SPALDING® BASKETBALL EQUIPMENT CATALOG
spaldingequipment.com

SPALDING IS PROUD TO PARTNER WITH:



Spalding is a division of Russell Brands, LLC

1-2	BREAKAWAY, FLEX & FIXED GOALS	13	OUTDOOR BACKSTOPS
3-4	FIXED GOALS, NETS & ACCESSORIES	14	IN-GROUND BASKETBALL SYSTEMS
5-7	GLASS BOARDS & PACKAGES	15-20	PORTABLE BACKSTOPS
8	BACKBOARD PADDING	21-22	BALL RACKS, TRAINING AIDS & SCORER'S TABLES
9	WALL-BRACED ADJUSTABLE BACKSTOPS	23-24	RESIDENTIAL IN-GROUND BACKSTOPS
10-11	GYMNASIUM COMPONENTS	25-26	RESIDENTIAL PORTABLE BACKSTOPS
12	PROTECTIVE WALL PADDING	27-28	RESIDENTIAL IN-GROUND & BASKETBALL ACCESSORIES

Spalding Basketball Equipment - Proven on the Court of Play

Spalding is the world's largest basketball equipment company. Spalding basketball products are trusted at every level, from the NBA All-Star Game to the backyard pick-up game. Spalding's extensive product line has something for every basketball team or enthusiast.

Spalding's experienced sales and dedicated customer service teams along with our national dealer network provide exceptional customer support. Spalding basketball equipment is built to last, withstanding the most aggressive play.

Arena® 180 Goal

- Official goal of the NBA
- High performance goal with 180-degree positive lock breakaway action for professional and collegiate play
- Factory calibrated to meet rebound elasticity requirements
- Padded cover plate with finger guard to prevent pinching
- Sound reducing padded cover plate
- Anti-whip net and mounting hardware included
- Seven-year warranty

413-583 Arena® 180 Goal w/5" x 4" Mounting Pattern



Slam-Dunk® Precision 180 Goal

- Official goal of the 2010 Men's and Women's Final Four
- High performance goal with 180-degree flex action for professional and collegiate play
- Adjustable reflex mechanism maintains NCAA and professional rebound elasticity
- Easy Glide #1 net system
- Meets all professional and NCAA specifications
- Anti-whip net and mounting hardware included
- Seven-year warranty
- U.S. Patent No. 5,716,294

413-577 Slam-Dunk® Precision 180 Goal w/5" x 5" Mounting Pattern
413-574 Slam-Dunk® Precision 180sb Goal w/5" x 4" Mounting Pattern



Meets NCAA rebound elasticity requirements



OFFICIAL SUPPLIER TO:

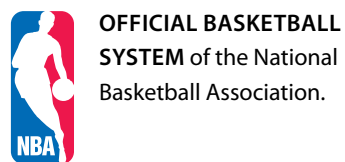

OFFICIAL BASKETBALL SYSTEM of the National Basketball Association.



OFFICIAL BASKETBALL SYSTEM of the Women's National Basketball Association.



OFFICIAL BASKETBALL EQUIPMENT SUPPLIER to the National Federation of High Schools.



OFFICIAL BASKETBALL SYSTEM of the NBA Development League.



OFFICIAL BASKETBALL & BACKBOARD to the NBA.



OFFICIAL BASKSTOP AND BACKBOARD SUPPLIER to the NCAA Men's and Women's Final Four.

Slam-Dunk® Goal

- High performance goal for collegiate play
- Factory calibrated to meet rebound elasticity requirements
- Top adjust positive lock release mechanism
- Easy Glide #2 net system on 411-704, Ram Horn on 411-705
- Meets all professional and NCAA specifications
- Anti-whip net and mounting hardware included
- Seven-year warranty

411-704 Slam-Dunk® Pro Goal w/ Universal Mounting Pattern
411-705 Slam-Dunk® Goal w/ Universal Mounting Pattern



Meets NCAA rebound elasticity requirements



Slammer Competition 180 Goal

- Performance goal with 180-degree flex action for high school and recreational play
- Adjustable reflex mechanism
- Easy Glide #2 net system
- Meets NFHS specifications
- Anti-whip net and mounting hardware included
- Five-year warranty

411-723 Slammer Competition 180 Goal Universal Mounting Pattern



SPALDING IS PROUD TO BE THE OFFICIAL GOAL SUPPLIER TO THE NFHS.



Slammer Competitor Goal

- Performance breakaway goal for high school and recreational play
- Positive lock breakaway mechanism
- Goal compatible with 5" x 5" or 5" x 4" mounting patterns
- Meets all NFHS specifications
- Two-year warranty

411-508 Slammer Competitor Goal w/ Universal Mounting Pattern (Ram Horn net system)

411-528 Slammer Competitor Goal w/ Universal Mounting Pattern (Easy Glide #2 net system)

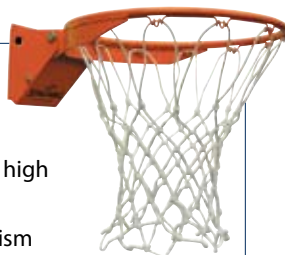

Super Goal

- Fixed goal for playground use
- Single ring configuration
- ½" diameter brace rods
- Continuous ram horn net system
- Goal compatible with 5" x 5" or 5" x 4" mounting patterns
- Nylon net and mounting hardware included
- One-year warranty

411-551 Super Goal Universal Mounting Pattern



Super Goal II

- Continuous ram horn net system
- 411-553 Super Goal II w/ Universal Mounting Pattern



Super Net

- One-year warranty
- 413-609 Super Net - 9 oz. Heavy-Duty Nylon Net



Anti-Whip Net

- One-year warranty
- 413-608 Anti-Whip - 7 oz. Heavy-Duty Nylon Net



Slammer Flex Goal

- Flex goal for recreational play
- Continuous ram horn net system
- Goal compatible with 5" x 5" or 5" x 4" mounting patterns
- Meets NFHS specifications
- Single ring configuration
- One-year warranty

411-506 Slammer Flex Goal w/ Universal Mounting Pattern

Slammer Flex Goal II

- Double ring configuration

411-507 Slammer Flex Goal II w/ Universal Mounting Pattern



Roughneck Gorilla Goal

- Fixed goal for aggressive play
- Single ring configuration
- 5/8" diameter brace rods
- Continuous ram horn net system
- Goal compatible with 5" x 5" or 5" x 4" mounting patterns
- Nylon net and mounting hardware included
- Unconditional lifetime warranty

411-556 Roughneck Gorilla Goal w/ Universal Mounting Pattern

Roughneck Gorilla Goal II

- Double ring configuration

411-557 Roughneck Gorilla Goal II w/ Universal Mounting Pattern



Hercules®

- Fixed goal for recreational play
 - Fits most rear mount boards
 - Single ring configuration
 - Continuous ram horn net system
 - Nylon net and mounting hardware included
 - Two-year warranty
- 411-554 Hercules® w/ Universal Mounting Pattern

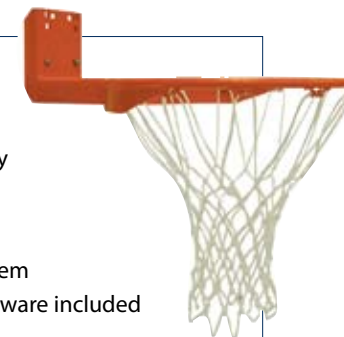

Hercules® II

- Double ring configuration
- 411-552 Hercules® II w/ Universal Mounting Pattern



Standard Net

- One-year warranty,
- 413-605 Standard Nylon Net - 5.6 oz.



Orange Touch-Up Spray Paint

- 008-086 Orange Touch-Up Spray for goals (12 oz.)



Arena® Backboard

- Official backboard of the NBA
- ½" tempered glass w/2" border and target
- Patented sub-frame mounting designed to prevent rim from touching the glass
- Compatible with main court portable backstops
- Meets all FIBA, NCAA, and NFHS specifications
- Lifetime warranty (vandalism, acts of nature, and outdoor use are not covered)

N413-002 Arena® Backboard 72" x 42"



OFFICIAL BACKBOARD TO THE NBA

• padding not included

SuperGlass Pro Backboard

- Official backboard of the 2010 Men's and Women's Final Four
- Regulation glass backboard for professional, collegiate and international competition
- ½" tempered glass w/2" border and target
- Patented sub-frame mounting designed to prevent rim from touching the glass
- Pre-drilled aluminum frame for bolt-on backboard padding
- Compatible with Wall-Braced, Ceiling-Suspended, and Portable units
- Meets all FIBA, NCAA, and NFHS specifications
- Lifetime warranty (vandalism, acts of nature, and outdoor use are not covered)

413-000 SuperGlass Pro Backboard 72" x 48"
413-001 SuperGlass Prosb Backboard 72" x 42"



OFFICIAL BACKBOARD SUPPLIER TO THE NCAA FINAL FOURS

• padding not included

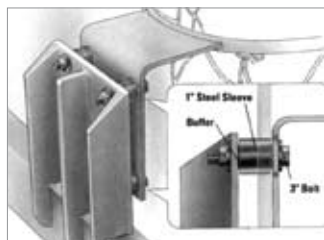

The SuperGlass Pro Backboard offers a unique buffer that acts as a pedestal preventing rim and rim bolts from ever touching the glass, thus eliminating stress and breakage.

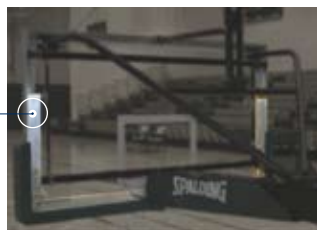

3" Strongback

The SuperGlass Pro Backboard comes standard with Strongback. This 3" channel stiffens the backboard, allowing for virtually vibration-free action.

SuperGlass Pro Backboard Package

- Includes:
- SuperGlass Prosb backboard (72" x 42") with lifetime warranty (413-001)
 - Slam-Dunk® Precision 180 Goal with 7-year warranty (413-574)
 - E-Z Bolt Backboard Padding with 5-year warranty (12 color options)

BB300-B SuperGlass Pro Backboard Package

Note: Colors shown in catalog and on website may not be an exact match. Please request a color swatch.



OFFICIAL BACKBOARD PACKAGE OF THE 2010 MEN'S AND WOMEN'S FINAL FOURS

SuperGlass Collegiate Backboard

- Regulation glass backboard for collegiate and high school competition
- ½" tempered glass w/2" border and target
- T-Plate distributes stress to backboard frame for strength and durability
- Compatible with side court portable backstops as well as Wall-Braced and Ceiling-Suspended units
- Board compatible with direct and four-point mounts
- Meets all NCAA and NFHS specifications
- Pre-drilled aluminum frame for bolt-on backboard padding
- Lifetime warranty on direct mounts only (vandalism, acts of nature, and outdoor use are not covered)

411-008 SuperGlass Collegiate Backboard 72" x 48"
411-007 SuperGlass Collegiatesb Backboard 72" x 42"



• padding not included

T-Plate technology



The SuperGlass Collegiate Backboard reduces stress on the backboard by evenly distributing the force applied to the goal. T-Plate hardware is hidden behind the backboard target making it invisible to players in game situations.

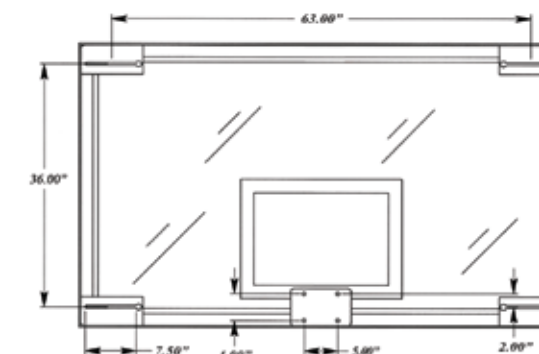

SuperGlass Collegiatesb Backboard 72" x 42"

COLLEGIATE PACKAGE OPTIONS



SUPERGLASS COLLEGIATE BACKBOARD package A

- Includes:
- SuperGlass Collegiatesb Backboard (72" x 42") with lifetime warranty (411-007)
 - Slam-Dunk® Prosb Goal with 7-year warranty (411-504)
 - E-Z Bolt Backboard Padding with 5-year warranty (12 color options)

BBS300 SuperGlass Collegiate Backboard Package

SUPERGLASS COLLEGIATE BACKBOARD package B

- Includes:
- SuperGlass Collegiatesb Backboard (72" x 42") with lifetime warranty (411-007)
 - Slammer Competition 180sb Goal with 5-year warranty (411-523)
 - E-Z Bolt Backboard Padding with 5-year warranty (12 color options)

BBS100 SuperGlass Collegiate Backboard Package

SUPERGLASS COLLEGIATE BACKBOARD package C

- Includes:
- SuperGlass Collegiatesb Backboard (72" x 42") with lifetime warranty (411-007)
 - Slammer Competitor Goal with 2-year warranty (411-528)
 - E-Z Bolt Backboard Padding with 5-year warranty (12 color options)

BBS200 SuperGlass Collegiate Backboard Package

SuperGlass Conversion^{sb} Backboard

- High performance glass backboard for collegiate and high school play
- Built-in adapter frame for upgrading from Fan Shaped to Rectangular Glass Backboard
- Backboard mounting dimensions: 35" x 20" (custom dimensions available)
- Pre-drilled aluminum frame for bolt-on backboard padding
- Twenty-year warranty

413-021 SuperGlass Conversion^{sb} Backboard 72" x 42"

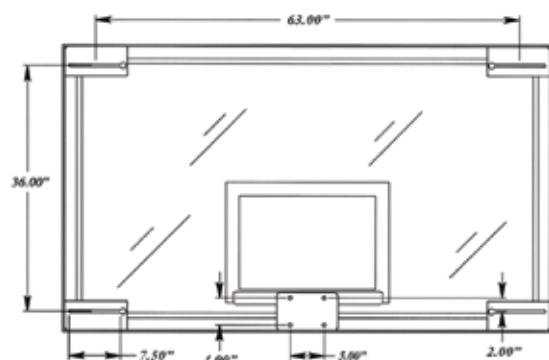

SuperGlass Conversion^{sb} Backboard 72" x 42"



padding not included



SPALDING IS PROUD TO BE THE OFFICIAL BACKBOARD SUPPLIER TO THE NFHS.

E-Z Bolt Padding for Glass Backboards

- Bolt-on backboard padding for rectangular glass backboards
- Constructed of molded urethane with 2 1/4" wide channel
- Meets FIBA, NBA, NCAA and NFHS specifications
- Eight bolts for easy attachment to 72" glass backboards (12 color options)
- Sold as each
- Five-year warranty

- 413-410 72" Maroon
- 413-411 72" Red
- 413-412 72" Orange
- 413-413 72" Gold
- 413-414 72" Gray
- 413-415 72" Kelly Green
- 413-416 72" Forest Green
- 413-417 72" Light Blue
- 413-418 72" Royal Blue
- 413-419 72" Navy
- 413-420 72" Purple
- 413-421 72" Black



413-419 72" Navy



12 color backboard padding options



Note: Colors shown in catalog and on website may not be an exact match. Please request a color swatch.

SuperGlass Conversion Backboard Package

- Includes:
- SuperGlass Conversion^{sb} Backboard (72" x 42") with 20-year warranty (413-021)
 - Slammer Competitor Goal with 2-year warranty (411-508)
 - E-Z Bolt Backboard Padding with 5-year warranty (12 color options)

BB300-H SuperGlass Conversion Backboard Package



12 color backboard padding options



SLAMMER COMPETITOR GOAL

Note: Colors shown in catalog and on website may not be an exact match. Please request a color swatch.

Bantam Backboard

- Smaller backboard for practice and recreational play, forcing players to focus on target area
- 1/2" tempered glass w/2" border and target
- Includes rim restrainer
- Backboard mounting pattern: 44 1/2" x 36"
- Goal mounting pattern: 5" x 5"
- Ten-year warranty

413-030 Bantam Backboard 54" x 42"



Peel 'N' Stick Padding for Glass Backboards

- Peel-off adhesive padding for 72" glass backboards
- Constructed of closed cell rubber with 2 1/4" wide channel
- Installs without drills or bolts
- Mitered corners for exact fit
- Meets FIBA, NBA, NCAA and NFHS specifications
- Sold as each
- One-year warranty

411-400 72" Gray

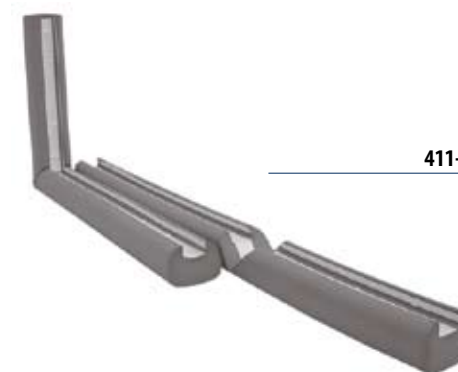

411-400 72" Gray



www.spaldingequipment.com





3-Point Wall Mount

3-Point Wall Mount

- Available in two models with adjustments ranging from 2 feet through 40 inches (302-725) or 40 inches through 6 feet (302-730)
- Three telescoping round tubes include locking bolts and allow for precise adjustment to court requirements
- Inner tube consists of 2" round steel extension covered by outer tube consisting of 2 3/8" round steel extension
- Supported by 1/4" steel cable
- 1/4" heavy-duty steel flanges attach at wall board and backboard locations
- Compatible with any 42" x 72" backboard with 5" x 4" goal mount pattern
- Gray powder coated finish only

302-725 Wall-Braced Adjustable Backstops (24" through 40")
302-730 Wall-Braced Adjustable Backstops (40" through 72")



Wall-Braced Stationary Backstop

Wall-Braced Stationary Backstop

- Available in extension lengths from 8"-13' from wall (extensions more than 1' 6" require 1/4" steel cable - cable included)
- Compatible with all Spalding backboards and height adjusters
- Four 2" square cross braces and extension tubes
- 1/4" heavy-duty flange at both pipe ends for attachment to wall boards and backboards
- Black powder coated finish (custom colors available)
- Five-year warranty

Please see price list for part numbers.



Wall-Braced Side Fold Backstop

Wall-Braced Side Fold Backstop

- Available in extension lengths from 3'-13' from wall (all extension lengths require 1/4" steel cable - cable included)
- Telescoping diagonal brace includes locking mechanism and adjustable collar allowing structure to be precisely placed in playing position from the floor utilizing a factory furnished hand crank
- Compatible with all Spalding backboards and height adjusters
- Four 2" square cross braces and extension tubes
- Off-set hinges with 1/4" heavy-duty flanges at wall board and backboard locations
- Black powder coated finish (custom colors available)
- Five-year warranty

Please see price list for part numbers.



Wall-Braced Fold-Up Backstop

Wall-Braced Fold-Up Backstop

- Available in extension lengths from 3'-13' from wall (all extension lengths require 1/4" steel cable - cable included)
- Includes 402-760 Manual Winch (optional QR4000 402-742 electric winch)
- Compatible with all Spalding backboards and height adjusters
- Four 2" square cross braces and extension tubes
- Hinges with 1/4" heavy-duty flanges at wall board and backboard locations
- 3 1/2" diameter deep-groove bronze bushing cable pulley for hoisting
- Black powder coated finish (custom colors available)
- Five-year warranty

Please see price list for part numbers.

Deluxe Key Switch for Electric Winch

- Two-year warranty

402-980 Deluxe Key Switch for Electric Winch



Remote Control Transmitter for Electric Winch

402-753

Remote Control Receiver for Electric Winch

- Two-year warranty

402-754 (not shown)

Remote Control Receiver for Height Adjusters, Divider Curtains, and Batting Cages

402-739 (not shown)



Portable Winch Operator

- Heavy-duty, high torque 1/2" angle-head drill motor allowing for electrical operation of manual winch
- One-year warranty

402-761 Portable Winch Operator and Socket

023-803 Spare Socket



Manual Winch

- Heavy-duty 1,000 lb. capacity
- Ample, oversized flanges prevent the cable from climbing drum ends
- Efficient 40:1 worm gear ratio
- Long-lasting, ball-bearing type thrust bearing
- Maintenance-free lifetime sealed gear case
- Five-year warranty

402-760 Manual Winch 1,000 lb. Capacity with Crank Handle

014-815 Replacement Handle



LynRus Aut-O-Loc Safety Belt

- Lightweight - only 14 lbs. / 6.43kg
- Rated for a maximum of 1,000 lbs. / 453.51kg
- Fully automatic
- Spring loaded to retract up to 35 feet. Optional 45 foot / 13.7 meter lead belt is also available
- Sets by internal force, for immediate and positive setting, or centrifugal force
- Five-year warranty

402-765 LynRus Aut-O-Loc Safety Belt for Backstops



Retractor Reel

- Automatically retracts support cable and safety straps keeping them out of playing area when backstop is in game position

401-875 Retractor Reel (not pictured)

LynRus QR4000 Electric Winch

- 115 volt, single phase, instantly reversing 3/4 HP motor
- Over 1,250 lbs. of vertical line pull at 9 feet per minute
- Large grooved drum with a 4 1/2" diameter
- High speed worm gear supported for both radial and thrust loads
- Positive locking - double reduction worm gear drive provides a 200:1 reduction rate
- Sealed gear case provides a lifetime of maintenance-free operation
- Includes Deluxe Key Switch
- Five-year warranty

402-742 LynRus QR4000 Electric Winch



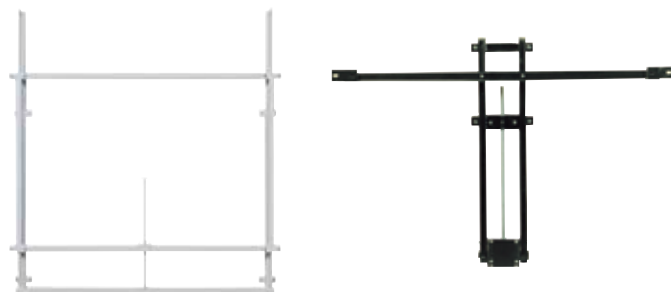

Manual Height Adjusters

- Enables backboard adjustment between 8-10 feet on Wall-Braced and Ceiling-Suspended Backstops
- Compatible with Fan Shaped and Rectangular Backboards on Single or Double Mast Backstops
- Large coupling nut provides maximum stability
- Black powder coated finish (custom colors available)
- Includes Crank Handle with Hook
- One-year warranty

- 313-334 for Fan and Conversion Backboards
- 313-337 for Bantam Backboard (54" x 42")
- 313-332 for Single Mast Backstop SuperGlass Collegiates^{sb} (72" x 42")
- 313-340 for Single Mast Backstop SuperGlass Collegiate (72" x 48")
- 313-333 for Double Mast or Wall-Braced SuperGlass Collegiates^{sb} (72" x 42")
- 313-335 for Double Mast or Wall-Braced SuperGlass Collegiate (72" x 48")

Other Height Adjuster Drive Assembly options available. Please contact factory for assistance.

Crank Handle Height Adjuster

313-323 HA-1055 Crank Handle Height Adjuster with Hook



Electric Height Adjusters

- Enables backboard adjustment between 8-10 feet on Wall-Braced and Ceiling-Suspended Backstops
- Compatible with Fan Shaped and Rectangular Backboards on Single or Double Mast Backstops
- Operated from floor with keyed switch or gymnasium controller
- Black powder coated finish (custom colors available)
- One-year warranty

- 313-344 for Fan and Conversion Backboards
- 313-347 for Bantam Backboard (54" x 42")
- 313-342 for Single Mast Backstop SuperGlass Collegiates^{sb} (72" x 42")
- 313-349 for Single Mast Backstop SuperGlass Collegiate (72" x 48")
- 313-343 for Double Mast or Wall-Braced SuperGlass Collegiates^{sb} (72" x 42")
- 313-345 for Double Mast or Wall-Braced SuperGlass Collegiate (72" x 48")

Electric Height Adjusters for Power Bar

- Electric Height Adjuster operated for Power Bar (shown at right)

- 313-354 for Fan and Conversion Backboards
- 313-357 for Bantam Backboard (54" x 42")
- 313-352 for Single Mast Backstop SuperGlass Collegiates^{sb} (72" x 42")
- 313-359 for Single Mast Backstop SuperGlass Collegiate (72" x 48")
- 313-353 for Double Mast or Wall-Braced SuperGlass Collegiates^{sb} (72" x 42")
- 313-355 for Double Mast or Wall-Braced SuperGlass Collegiate (72" x 48")
- 313-360 Power Bar (sold separately)



Digital Graphic Wall Pads

Digital Graphic Wall Pads

All digital graphics are done using state-of-the-art, six-color large format printers. Durable, vivid inks combined with our lamination process ensure that your padding will outlast the silk-screens and vinyl applications of the past. High resolution printing provides sharp image quality from any distance.

Customization Made Easy

- Any Spalding Wall Pad can be custom printed to match your logo and color scheme specifications
 - Full color printing allows unlimited color options
 - Artwork is printed directly onto vinyl covers and attached to backing material
- Please contact the factory for ordering information and specifications on custom digital graphics.



2" Bonded Wall Padding

2" Polyurethane Wall Pads

- 2 7/16" (62mm) thick protective wall padding that can be permanently installed or removable *
 - Constructed of 7/16" (11mm) O.S.B backing, 2" 100 ILD polyurethane foam and 14 oz. vinyl cover
 - Choose from a variety of standard colors
 - Vinyl cover meets National Fire Protection Standard 701
- Please contact the factory for ordering information.

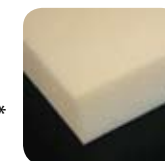

2" 100 ILD Polyurethane Wall Pads

2" Bonded Wall Pads

- 2 7/16" (62mm) thick protective wall padding that can be permanently installed or removable *
 - Constructed of 7/16" (11mm) O.S.B backing, 2" bonded foam and 14 oz. vinyl cover
 - Choose from a variety of standard colors
 - Vinyl cover meets National Fire Protection Standard 701
- Please contact the factory for ordering information.

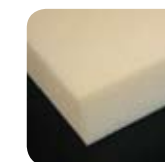

2" Bonded Wall Pads

Class A Fire Wall Pads

- 2 7/16" (62mm) thick protective wall padding that can be permanently installed or removable *
 - Constructed of 7/16" (11mm) fire retardant O.S.B backing, 2" polychloroprene foam and 14 oz. vinyl cover
 - Class A Fire Rating (meets ASTM E84 testing procedures)
 - Choose from a variety of standard colors
 - Vinyl cover meets National Fire Protection Standard 701
- Please contact the factory for ordering information.



Class A Fire Wall Pads

*All Wall Pads available with either 1" nailing margin or Z-Clip attachment.

6# Rebond Wall Pads

- 2 7/16" (62mm) thick protective wall padding that can be permanently installed or removable *
 - Constructed of 7/16" (11mm) O.S.B backing, 2" 6# rebond foam and 14 oz. vinyl cover
 - Choose from a variety of standard colors
 - Vinyl cover meets National Fire Protection Standard 701
- Please contact the factory for ordering information.

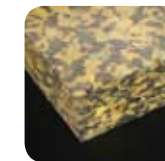

6# Rebond Wall Pads

Steel Backboard

- Regulation-size steel backboard for indoor/outdoor play
- White electrostatic powder coated with graffiti resistant finish
- Backboard mounting pattern: 63" x 36"
- Goal mounting pattern: 5" x 4"
- One-year warranty; Lifetime warranty on direct mounts (vandalism and acts of nature are not covered)

413-062 Steels**b** Backboard 72" x 42"
 411-054 Steel Bantam Backboard 54" x 39"

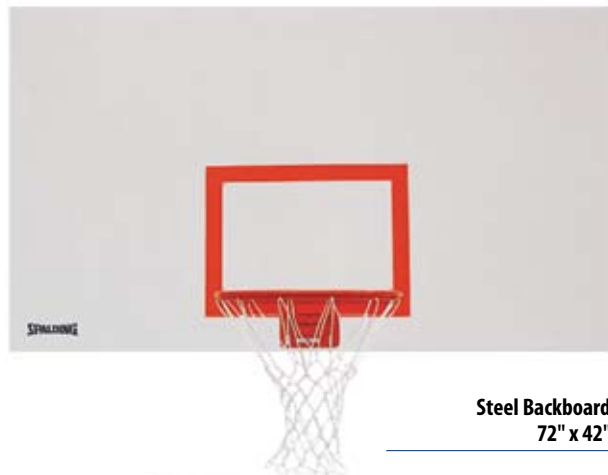

Steel Backboard
72" x 42"

Steel Front Mount Fan Backboard

- Regulation-size Steel Fan Backboard for indoor/outdoor play
- Reinforce with horizontal channels designed for vibration-free action
- Vertical strongback that strengthens the critical rim area
- Specially designed bolt keeper system allows for easy installation
- Recommended for direct mount with OD1 Gooseneck Pole
- Backboard mounting pattern: 35" x 20"
- Goal mounting pattern: 5" x 5"

413-209 Steel Front Mount Fan Backboard 54" x 39" (pictured)
 413-208 Steel Front Mount Fan Backboard 54" x 39" w/orange target (not pictured)



Fiberglass Backboard

- Regulation-size fiberglass backboard for indoor/outdoor play
- 1 1/8" thick high density thermally fused panel
- Three layers of fiberglass on the face and two layers on the back
- Hand laminated for added strength
- Gel Coat sealant provides a moisture-resistant barrier
- Backboard mounting pattern: Fiberglass Backboard 63" x 42"; Fiberglass**b** Backboard 63" x 36"
- Goal mounting pattern: Fiberglass Backboard 5" x 5"; Fiberglass**b** Backboard 5" x 4"
- Ten-year warranty: outdoor; Lifetime warranty on direct mounts for indoor use (vandalism and acts of nature are not covered)

413-050 Fiberglass Backboard 72" x 48"
 413-051 Fiberglass**b** Backboard 72" x 42"



Fiberglass Backboard
72" x 48"

Fiberglass Fan Backboard

- Backboard mounting pattern: 31 1/2" top / 37" bottom x 20"
- Goal mounting pattern: 5" x 5"

413-230 Fiberglass Fan Backboard 54" x 39"



OD1 Gooseneck Pole

- Galvanized gooseneck poles available in 3 1/2" or 4 1/2" O.D. and 3'; 4' and 5' extensions
- Unconditional lifetime warranty
- Sleeve not included - Cement directly to the ground

- 402-801 3 1/2" O.D. Pole with 3' extension
 - 402-815 SL1 sleeve for OD1 Gooseneck Pole
- 402-800 4 1/2" O.D. Pole with 4' extension
 - 402-816 SL1A sleeve for OD1A/OD1B Gooseneck Pole
- 402-822 4 1/2" O.D. Pole with 5' extension
 - 402-816 SL1A sleeve for OD1A/OD1B Gooseneck Pole
- 411-801 4 1/2" Rear Mount Gooseneck Pole with 4' extension
 - 402-816 SL1A sleeve for OD1A/OD1B Gooseneck Pole

OD1 Gooseneck Pole Systems

- Systems include Gooseneck Pole, Steel Fan Backboard and Roughneck Gorilla Goal
- OD1 Gooseneck Pole Systems are available in multiple configurations to fit all your playground needs
- Sleeve not included - Cement directly to the ground

Please see price list for part numbers and configurations.



OD658 Enforcer Pole System

- System includes a 6 5/8" O.D. galvanized steel pole, Steels**b** Backboard, and Roughneck Gorilla Goal
- 6' of run-out room from backboard to pole
- Unconditional lifetime warranty
- Sleeve not included - Cement directly to the ground

402-825 OD658 Enforcer Pole System
 402-807 OD658 Enforcer Pole
 402-824 SL6 sleeve for OD658 Enforcer Pole



OD6 Dominator Pole System

- System includes a 6" square pole, Steels**b** Backboard and Roughneck Gorilla Goal (components can be purchased separately)
- Black powder coated finish
- Unconditional lifetime warranty
- Sleeve not included - Cement directly to the ground

402-806 OD6 Dominator Pole System
 402-797 OD6 Dominator Pole
 402-820 SL6 Dominator Pole

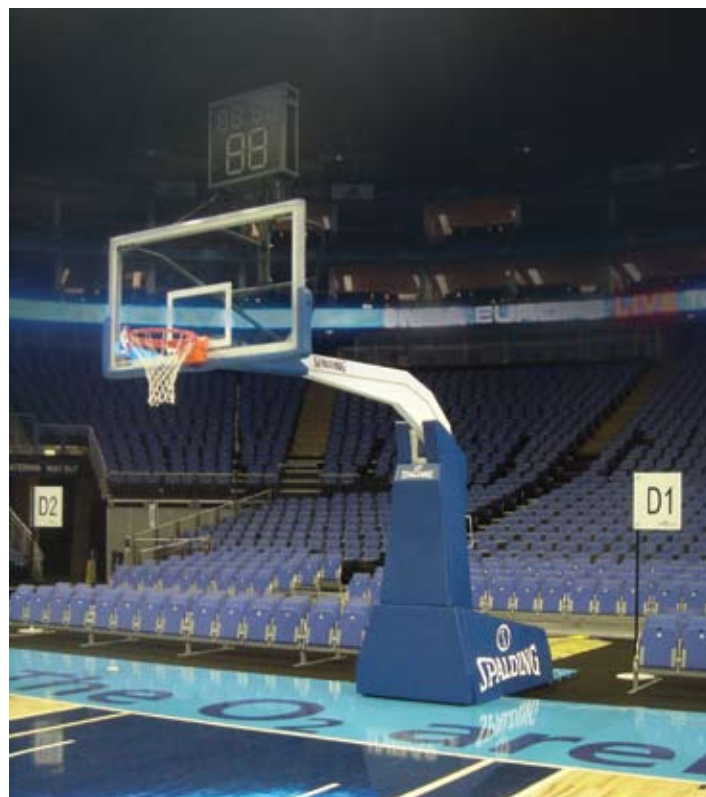

THE O2 ARENA - London



OFFICIAL BASKETBALL SYSTEM OF THE NBA



OFFICIAL BASKETBALL SYSTEM OF THE WOMEN'S NBA



OFFICIAL BASKETBALL SYSTEM OF THE NBA DEVELOPMENT LEAGUE



OFFICIAL BACKSTOP OF THE 2010 NBA ALL-STAR GAME



OFFICIAL BASKETBALL & BACKBOARD OF THE NBA



OFFICIAL BACKSTOP OF THE 2010 MEN'S AND WOMEN'S FINAL FOURS

G8 Portable Backstop

- Main court backstop for high school and intramural competition
- 8' distance from backboard to front pad. Height adjustable: 6' - 10'
- Spring assisted lifting mechanism
- 3" thick padding available in 300+ colors
- White powder coated finish (custom colors available)
- 1,000 lbs. of ballast
- Rolls on 8 - 6" x 2" urethane wheels rated for 900 lbs. each
- Shot clock holder and wiring, protective cover, and logo pads sold separately
- Optional rims available for multiple levels of play
- System includes: SuperGlass Collegiate Backboard; Slam-Dunk® Precision 180 Goal; E-Z Bolt and base padding; floor anchor
- Warranty: Backstop and lifting mechanism, 10-year; SuperGlass Collegiate Backboard, lifetime; Slam-Dunk® Precision 180 Goal, 7-year; Backboard padding, 5-year

401-975 G8 Portable Backstop



Arena® Backstop

- Available in 10' 8" and 8' extensions to meet all professional, collegiate, high school and international specifications
- Quickly raise and lower the unit with custom high-torque DC electric motor, coupled with a massive 1 1/2" diameter lead screw
- Auto Lift Mechanism (ALM) system for one step set-up without tools
- System uses a standard 110V 20 amp circuit
- SuperGlass Pro Backboard with unconditional lifetime warranty
- Slam-Dunk® Precision 180 Goal with unconditional 7-year warranty
- 4" thick protective padding covered in 30 oz. vinyl
- Infinite height adjustment from 8' to 10' with visual height indicator
- Electrostatic powder coated finish available in custom colors
- Rolls on six 6" x 2" casters for maximum load dispersion
- Counterweight of 1800 to 2000 lbs. for superior stability
- Floor anchor system compatible with all surfaces

401-890 Arena® Backstop with 10' 8" extension
401-880 Arena® Backstop with 8' extension

Arena® Backstop-Spring Assist

- Available in 10' 8" and 8' extensions to meet all professional, collegiate, high school and international specifications
- Spring assisted lifting mechanism
- Auto Lift Mechanism (ALM) system for one step set-up without tools
- SuperGlass Pro Backboard with unconditional lifetime warranty
- Slam-Dunk® Precision 180 Goal with unconditional 7-year warranty
- 4" thick protective padding covered in 30 oz. vinyl
- Positive lock at 8', 9' and 10' playing heights
- Electrostatic powder coated finish available in custom colors
- Rolls on six 6" x 2" casters for maximum load dispersion
- Counterweight of 1800 to 2000 lbs. for superior stability
- Floor anchor system compatible with all surfaces

401-990 Arena® Backstop-Spring Assist with 10' 8" extension
401-980 Arena® Backstop-Spring Assist with 8' extension

G5 Portable Backstop

- Side court backstop for college and professional practice
- 5' distance from backboard to front pad. Height adjustable: 6' - 10'
- Spring assisted lifting mechanism
- 3" thick padding available in 300+ colors
- White powder coated finish (custom colors available)
- 960 lbs. of ballast
- Rolls on 8 - 6" x 2" urethane wheels rated for 900 lbs. each
- Shot clock holder and wiring, protective cover, and logo pads sold separately
- Optional rims available for multiple levels of play
- System includes: SuperGlass Collegiate Backboard; Slam-Dunk® Precision 180 Goal; backboard and base padding; floor anchor
- Protective covers and logo pads sold separately
- Warranty: Backstop and lifting mechanism, 10-year; SuperGlass Collegiate Backboard, lifetime; Slam-Dunk® Precision 180 Goal, 7-year; Backboard padding, 5-year

401-970 G5 Portable Backstop



available
SUMMER 2010

2500 Portable Backstop

- Versatile glass backboard portable basketball system for schools, colleges and churches
- 72" x 42" high performance, aluminum framed glass backboard (413-012)
- Backboard is made of 1/2" tempered glass
- Slammer Competitor Goal (411-508)
- Extension arm provides 5' of offset at 10' goal height
- Spring assisted one lever height adjustment (no tools needed)
- Goal height is adjustable from 8' to 10'
- Will fit through standard double door with backboard lowered
- Rolls on 4 - 4" wheels rated for 600 lbs. each
- Multi-piece base padding included (black)
- Backstop contains 725 lbs. of ballast
- Warranty: Backstop frame, 10-year; Telescoping brace, 2-year; Floor pedestals, 2-year; Backboard, 10-year; Slammer Competitor Goal, 2-year

401-879 2500 Portable Backstop

Spalding 2500 Portable storage dimensions: 115" long x 78" high x 72" wide

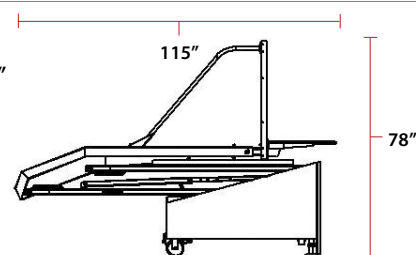

Street Tournament Portable Backstop

- Designed for street tournament play
- Extension arm provides 3' of offset at 10' goal height
- 54" x 38" acrylic backboard with steel back framework
- Slammer Flex Goal included (411-506)
- Rim height is adjustable from 8' to 10'
- Backboard folds down for storage
- Base padding included (black)
- Additional ballast weight required—500 recommended lbs. (not included)
- One-year limited warranty

411-790 Street Tournament Portable Backstop

Spalding Street Tournament Portable storage dimensions:

116 3/4" long x 35" high x 54" wide

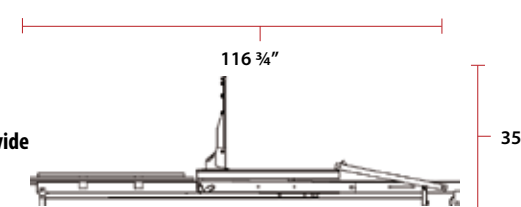

Spalding Street Tournament Portable Backstop

Ballast Plate

2000 Portable Backstop

- Versatile glass backboard portable basketball system for schools, colleges and churches
- 54" x 42" high performance, aluminum framed glass backboard (411-798)
- Backboard is made of 1/2" tempered glass
- Slammer Competitor Goal (411-528)
- Extension arm provides 5' of offset at 10' goal height
- Spring assisted one lever height adjustment (no tools needed)
- Goal height is adjustable from 7' 6" to 10'
- Will fit through standard double door with backboard lowered
- Rolls on 4 - 4" wheels rated for 600 lbs. each
- Multi-piece base padding included (black)
- Backstop contains 725 lbs. of ballast
- Warranty: Backstop frame, 10-year; Telescoping brace, 2-year; Floor pedestals, 2-year; Backboard, 10-year; Slammer Competitor Goal, 2-year

411-800 2000 Portable Backstop

Spalding 2000 Portable storage dimensions: 119" long x 77 1/2" high x 54" wide

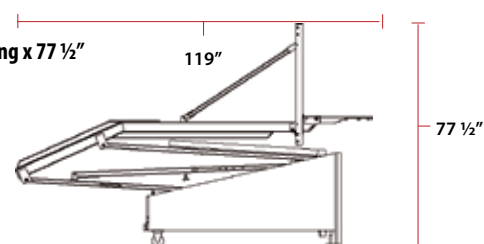

Fastbreak 960 Portable Backstop

- Designed for institutional use at high schools, camps, churches or health clubs
- 60" x 36" high performance, aluminum framed acrylic backboard (411-772)
- Backboard is 3/8" thick acrylic sheet for superior rebound
- Extension arm provides 6' of offset at 10' goal height
- Pro Image™ Breakaway Goal (411-511)
- Goal height is adjustable from 7' to 10'
- Easily folded by two people in less than two minutes
- Multi-piece base padding included (black)
- Additional ballast weight required—450-550 recommended lbs. (not included)
- Two-year limited warranty

411-870 Fastbreak 960 Portable Backstop

Fastbreak 960 Portable storage dimensions: 117" long x 52" high x 60" wide

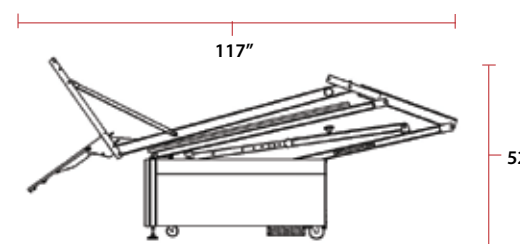

Fastbreak 960 Portable Backstop

Ballast Storage Compartment



Spalding 2500 Portable Backstop



Spalding 2000 Portable Backstop



Fastbreak 940 Portable Backstop

- Designed for elementary schools, recreation centers, or as a superior home unit
- 54" x 32" high performance, aluminum framed acrylic backboard (411-783)
- Backboard is 3/8" thick acrylic for superior rebound
- Extension arm provides 6' of offset at 10' goal height
- Pro Image™ Breakaway Goal (411-511)
- Rim height is adjustable from 7' x 10'
- Backboard folds down for storage
- Multi-piece base padding included (black)
- Additional ballast weight required—450-550 recommended lbs. (not included)
- Two-year limited warranty

411-860 Fastbreak 940 Portable Backstop

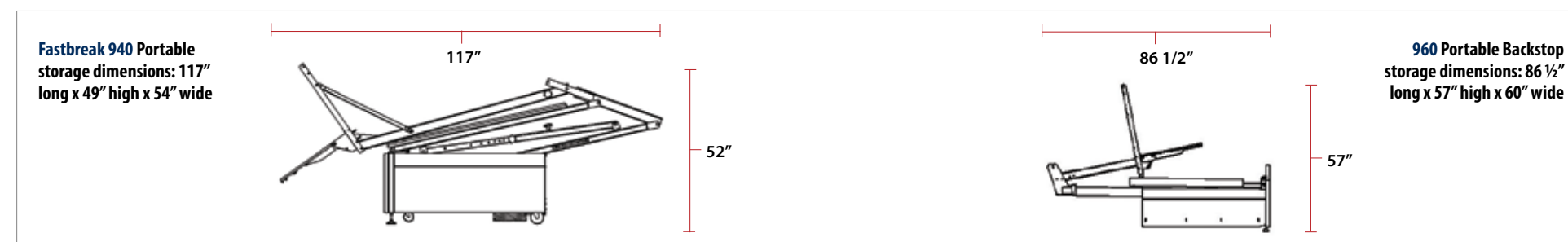

Fastbreak 930 Portable Backstop

- Pole system and backboard tip back for easy movement on built-in wheels
- Quick set up and take down
- Eco-Composite Backboard is 48" x 33" (421-254)
- Arena Slam™ Breakaway Goal
- Acrylic Backboard is 48" x 32" (421-835)
- Telescoping poles easily adjust goal height from 7' to regulation 10'
- All steel, welded construction
- Base has vinyl trim to avoid marring floors
- Includes full front padding (black)
- Additional ballast required—200 recommended lbs. (not included)
- Two-year limited warranty
- Base dimensions: 35 1/4" x 19 3/4" x 13 1/4"

411-850 Fastbreak 930 Portable Backstop

411-835 Fastbreak 930 Portable Backstop w/ Acrylic backboard

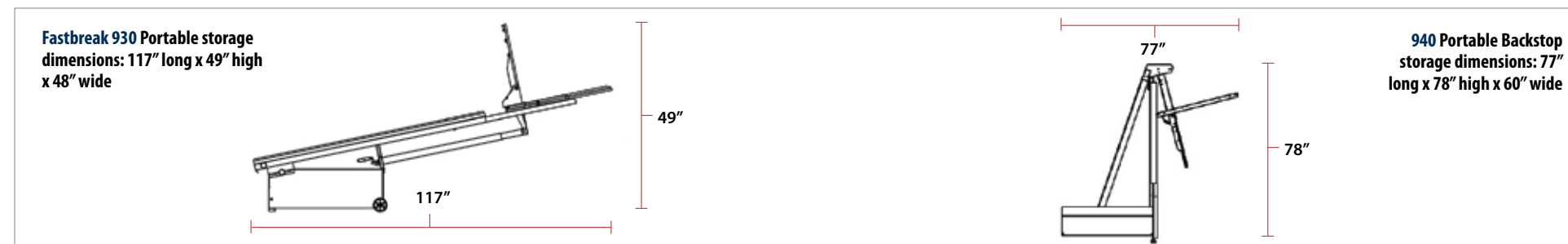

940 Portable Backstop

- Designed for elementary schools, recreation centers, or as a top quality home unit
- Extension arm provides 3' of offset at 10' goal height
- Pro Image™ Breakaway Goal (411-511)
- Rim height is adjustable from 6'6" to 10'
- Backboard folds down for storage
- Multi-piece base padding included (black)
- Additional ballast weight required—300-350 recommended lbs. (not included)
- Two-year limited warranty

411-780 940 Portable Backstop





Replica Pro Ball Rack

- Constructed of durable chrome steel tubing
- Swivel casters
- Non-topple base
- Angled rails for easy ball removal

411-602 Replica Pro Ball Rack



Collegiate Ball Rack

- Constructed of chrome steel tubing
- Swivel casters
- Non-topple base
- Holds up to 16 balls

411-601 Collegiate Ball Rack



Scholastic Ball Rack

- Constructed of chrome steel tubing
- Swivel casters
- Non-topple base
- Holds up to 12 balls

411-600 Scholastic Ball Rack



Ball Locker

- Constructed of welded steel
- Non-marring swivel casters
- Lockable
- Holds up to 30 balls

411-605 Ball Locker



Folding Bounce Back

- Net frame angles up or down for all types of return passes
- Heavy-duty net and bands
- Folds for compact storage
- Self standing
- Built-in weight tubes eliminates the need for weight bags

411-627 Folding Bounce Back



Wheeled Bounce Back

- Net frame angles up or down for all types of return passes
- Skid-resistant wheels
- Heavy-duty net and bands
- 3/16" steel, rolling base with easy operating brake
- Net frame is removable in seconds without tools
- Single clamp height adjustment

411-624 Wheeled Bounce Back

McCall's Rebounder

- Known as one of the best rebound skill builder on the market
- Sharpens players' rebounding skills
- Ideal tool for increasing grip strength and vertical leap
- Helps improve balance, timing and perception under the rim
- Adjustable from 7' to 12'
- Transports easily on built-in smooth rolling casters

411-621 McCall's Rebounder



McCall's Rebounder



Portable Scorer's Table

- Heavy-duty folding table for courtside use
- Accommodates four chairs
- Solid steel welded construction
- Folds in seconds for mobility and storage
- Built-in non-marking casters for easy transportation
- Access holes for routing cables
- UL electrical duplex outlet and extension
- Logo and/or school name - one color only for additional fee
- 14 oz. vinyl padding on visible sides (specify color)
- 8'4" x 36" x 34" unfolded for game use, 52" x 21 1/2" x 34" folded for storage
- 205 lbs. shipping weight, 52" x 36" x 24" shipping size

411-670 Black	411-674 Kelly Green	411-678 Purple
411-671 Forest Green	411-675 Maroon	411-679 Royal Blue
411-672 Gold	411-676 Navy	411-680 Rich Red
411-673 Gray	411-677 Orange	

Note: Colors shown in catalog and on website may not be an exact match. Please request a color swatch.

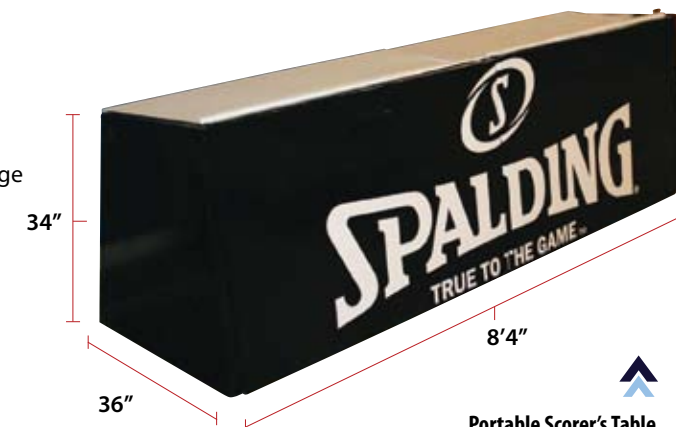

Portable Scorer's Table pictured unfolded

Digital Graphic Scorer's Table

- Spalding's durable and convenient scorer's tables are now available with custom printed, full color padding
- All digital graphics are done using state-of-the-art, six-color large format printers
- Durable, vivid inks ensure that your padding will outlast the silk-screens and vinyl applications of the past
- Our lamination process decreases the likelihood of scratching as well as regular wear-and-tear from daily use

Please contact factory for additional information.



Digital Graphic Scorer's table pictured, unfolded

ARENA VIEW® SERIES



180° Rim

4" x 5" Pro Style Rim with 180° Breakaway Action Patented 180° Goal



Rim Mount

Goal Mounting Configuration prevents the rim and bolts from touching the glass or acrylic, reducing stress and breakage



Hinging Base Plate

Enables ground level assembly of backboard and rim Patent Pending



Z-Arms

For improved stability and leveling, reducing board breakage



Safety Stop

Prevents goal from being lowered below 6' 6"



U-Turn™ Pro

Provides infinite height adjustment from 7' - 10'



Arena View® System



Arena View® Series

Arena View® 88724AGP 72" GLASS

Board Size: 72" x 42"
Board: ½" Tempered Glass
Board Pad: Arena
Board Frame: Steel
Board Offset: 4'

Rim Style: 180° Breakaway
Lift System: U-Turn™ Pro
Lift Handle: Removable
Pole Size: 1 Pc, 8" Square
Pole Material: Steel
Pole Pad: Stadium Style

421-000 Arena View® 88724AGP - Glass
421-001 Arena View® 88724AAP - Acrylic

Arena View® 86604AGP 60" GLASS

Board Size: 60" x 38"
Board: ½" Tempered Glass
Board Pad: Arena
Board Frame: Steel
Board Offset: 3'

Rim Style: 180° Breakaway
Lift System: U-Turn™ Pro
Lift Handle: Removable
Pole Size: 1 Pc, 6" Square
Pole Material: Steel
Pole Pad: Stadium Style

421-002 Arena View® 86604AGP

Arena View® 886724FS 72" ACRYLIC

Board Size: 72" x 42"
Board: ½" Acrylic
Board Frame: Steel
Board Offset: 4'

Rim Style: 180° Breakaway
Pole Size: 1 Pc, 6" Square
Pole Material: Steel
Lift System: Not adjustable

421-006 Arena View® 886724FS

88880G 72" GLASS

Board Size: 72" x 42"
Board: ¾" Tempered Glass
Board Frame: Steel
Board Offset: 4'
Rim Style: Flex Breakaway

Lift System: U-Turn™ Pro
Lift Handle: Removable
Pole Size: 1 Pc, 6" Square
Pole Material: Steel
Pole Pad: Heavy Duty

421-123 88880G

88830G 60" GLASS

Board Size: 60" x 38"
Board: ¾" Tempered Glass
Board Frame: Steel
Board Offset: 3'
Rim Style: Flex Breakaway

Lift System: U-Turn™ Pro
Lift Handle: Removable
Pole Size: 1 Pc, 6" Square
Pole Material: Steel
Pole Pad: Heavy Duty

421-120 88830G

88825G 54" GLASS

Board Size: 54" x 36"
Board: ¾" Tempered Glass
Board Frame: Steel
Board Offset: 3'
Rim Style: Flex Breakaway

Lift System: U-Turn™ Pro
Lift Handle: Removable
Pole Size: 1 Pc, 5" Square
Pole Material: Steel
Pole Pad: Heavy Duty

421-121 88825G



iHoop™

IP556 54" Glass

Board Size:	54"	Lift System:	Screw Jack
Board:	¼" Tempered Glass	Lift Handle:	Removable
Board Frame:	Steel	Pole Size:	2 Pc, 4" Square
Board Offset:	2'	Pole Material:	Steel
Rim Style:	Arena Slam™	Pole Angle:	20°

PREMIUM SOUND SYSTEM

Compatible with Most iPod® Models* and MP3 Players

- System Power:** 120V with GFI Protection
- Speaker Type:** Two 3" Full Range, One 5" Subwoofer
- Speaker Grade:** Marine Grade, Weather Resistant
- Construction:** Impact Resistant ABS Material
- Other:** iPod®/MP3 Suspension Cradle for Protection

421-199 iHoop™ IP556



*Compatible with iPod 1st & 2nd generation 5GB, 10GB, 20GB • iPod 3rd generation 10GB, 15GB, 20GB • iPod 3rd generation 30GB, 40GB • iPod mini 4GB, 6GB • iPod 4th generation 20GB • iPod 4th generation 40GB • iPod 4th generation (color display) 20GB, 30GB • iPod 4th generation (color display) 40GB, 60GB • iPod shuffle 1st generation 512MB, 1GB • iPod nano 1st generation 1GB, 2GB, 4GB • iPod 5th generation (video) 30GB • iPod 5th generation (video) 60GB, 80GB • iPod nano 2nd generation (aluminum) 2GB, 4GB, 8GB • iPod shuffle 2nd generation 1GB, 2GB • iPod classic 80GB, 160GB • iPod nano 3rd generation (video) 4GB, 8GB • iPod classic 120GB • iPod nano 4th generation (video) 8GB, 16GB, power drop cord required by user

68564 54" Acrylic

Board Size:	54"	Lift System:	Screw Jack
Board:	¾" Acrylic	Lift Handle:	Removable
Board Frame:	Steel	Pole Size:	3 Pc, 3.5" Round
Board Offset:	16"	Pole Material:	Steel
Rim Style:	Arena Slam™	Pole Angle:	20°
Base:	40 Gallon Ballast	Board Pad:	Authentic Style
Front Cover:	Rebounder during play	Wheels:	2

421-197 Portable System 68564



THE BEAST

74560 The Beast®

Board Size:	60"	Lift System:	Screw Jack
Board:	¼" Tempered Glass	Lift Handle:	Removable
Board Frame:	Steel	Pole Size:	2 Pc, 5" Square
Board Offset:	2'	Pole Material:	Steel
Rim Style:	Pro Image™	Pole Angle:	20°
Base:	55 Gallon Power Move™	Wheels:	4
Front Cover:	Pre-play movement and during play rebounder		

421-232 The Beast® 74560



Patented Multi-Wheel Design

66349 50" Polycarbonate

Board Size:	50"	Lift System:	ExactaHeight™
Board:	Polycarbonate	Pole Size:	3 Pc, 3.5" Round
Board Frame:	Steel	Pole Material:	Steel
Board Offset:	14"	Pole Angle:	20°
Rim Style:	Pro Slam®	Board Pad:	Authentic Style
Base:	34 Gallon Ballast	Wheels:	2
Front Cover:	Rebounder during play		

421-248 Portable System 66349



68454 54" GLASS

Board Size:	54"	Lift System:	Screw Jack
Board:	¼" Tempered Glass	Lift Handle:	Removable
Board Frame:	Steel	Pole Size:	3 Pc, 4" Square
Board Offset:	2'	Pole Material:	Steel
Rim Style:	Arena Slam™	Board Pad:	Foam
Base:	40 Gallon Ballast	Wheels:	2
Front Cover:	Rebounder during play		

421-214 Portable System 68454

63559 44" Advanced Eco-Composite™

Board Size:	44"	Lift System:	Telescoping
Board:	Advanced Eco-Composite™	Pole Size:	3 Pc, 2.75" Round
Board Frame:	Steel	Pole Material:	Steel
Rim Style:	Standard	Wheels:	1
Base:	26.5 Gallon Ballast		

421-262 Portable System 63559





Pole Padding

80885

- 8" square stadium style pole and gusset pad
- 2" thick black vinyl dense foam
- For use with 8" pole only

421-278 80885

8056

- Heavy duty pole pad
- 1 1/2" foam pad
- Fits 5" and 6" square poles

421-279 8056

8040

- Heavy duty pole pad
- 1 1/2" foam pad
- Fits 3", 3 1/2" and 4" round or square poles

421-281 8040



Board Padding

16672

- Heavy duty pro style black foam board pad
- 1" thick closed cell foam
- Fits 72", 1" x 2" board frames

421-275 16672

16660

- Heavy duty pro style black foam board pad
- 1" thick closed cell foam
- Fits 60", 1" x 2" board frames

421-276 16660

16654

- Heavy duty pro style black foam board pad
- 1" thick closed cell foam
- Fits 54", 1" x 2" board frames

421-277 16654



Goals

180° BREAKAWAY GOAL

Patented 180° Goal
411-526 - 4" x 5" 180° Breakaway Goal

POSITIVE LOCK GOAL

(not pictured)
411-519 - 4" x 5" Positive Lock Goal

FLEX GOAL

411-527 - 4" x 5" Flex Goal

PRO IMAGE™ GOAL

411-511 - 3" x 4" Pro Image™ Goal

Court Marking Kit

- Create a regulation court on your driveway

421-011 Court Marking Kit



Inflating Needles

- Two Metal Inflating Needles

421-322 Inflating Needles



12" Pump with Gauge

- Power pump w/ psi gauge, metal needle and toy adapter

421-312 12" Pump with Gauge



12" Pump

- 12" all purpose pump w/ metal needle and toy adapter

421-313 12" Pump



8" Pump

- 8" all purpose pump w/ metal needle and toy adapter

421-314 8" Pump



Electronic Whistle

- 3 Tone Settings
- Consistent Sound
- Fast Action

421-327 Whistle



All Weather Net-R/W/B

- Red / White / Blue
- All Weather Net

421-318 All Weather Net-R/W/B



Heavy Duty Net-White

- Heavy duty regulation size net

421-315 Heavy Duty Net-White



All Weather Net-White

- White Net
- All Weather Net

421-317 All Weather Net-White



Heavy Duty Net-R/W/B

- Red / White / Blue
- Heavy duty regulation size net

421-316 Heavy Duty Net-R/W/B



Ball not included

Pub Table

- 30" diameter commercial grade acrylic top with complete beveled edge
- 44" high, powder coated black, steel structure
- Regulation size goal
- White net
- Assembled dimensions 43" x 30" x 30"

421-354 Pub Table

Sports Table

- 24" diameter acrylic table top
- Regulation size steel goal
- Wood grain base
- White net
- Assembled dimensions 24" x 24" x 24"

421-355 Sports Table



Mesh Bag

- Mesh equipment bag with drawstring
- Holds up to 7 balls

411-608 Mesh Bag

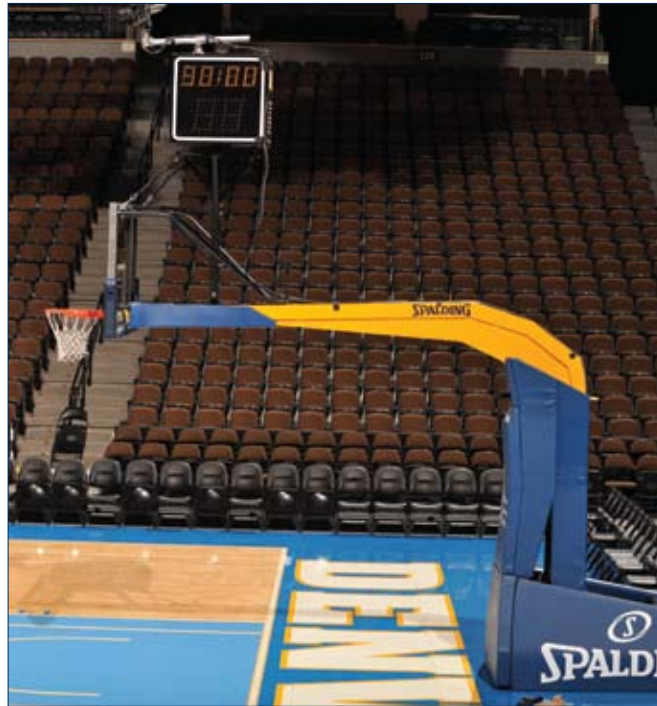

DENVER NUGGETS
Denver, CO

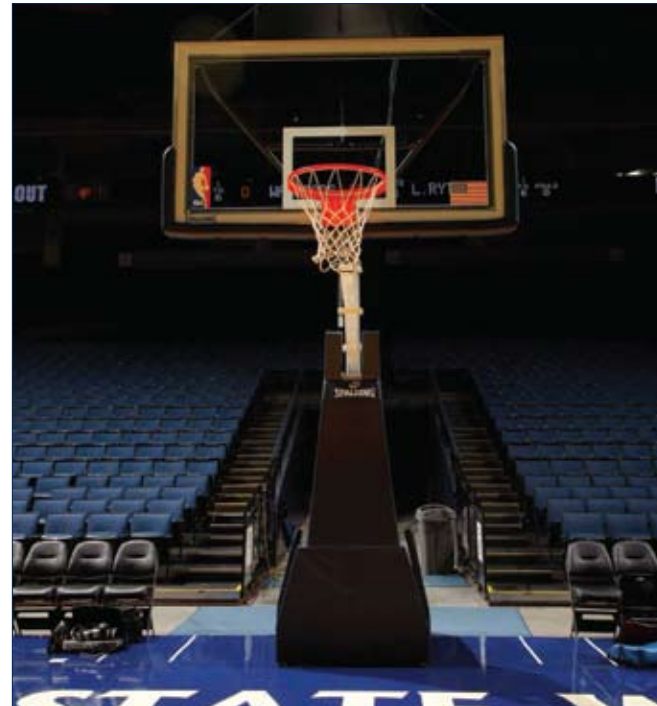

GOLDEN STATE WARRIORS
Oakland, CA



PHILADELPHIA 76ERS
Philadelphia, PA

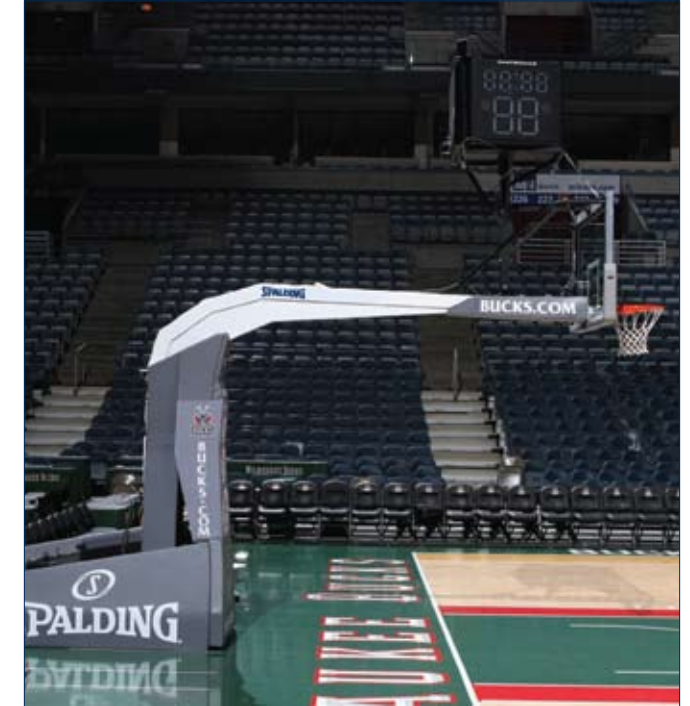

MILWAUKEE BUCKS
Milwaukee, WI



SAN ANTONIO SPURS
San Antonio, TX



SAN ANTONIO SPURS
San Antonio, TX

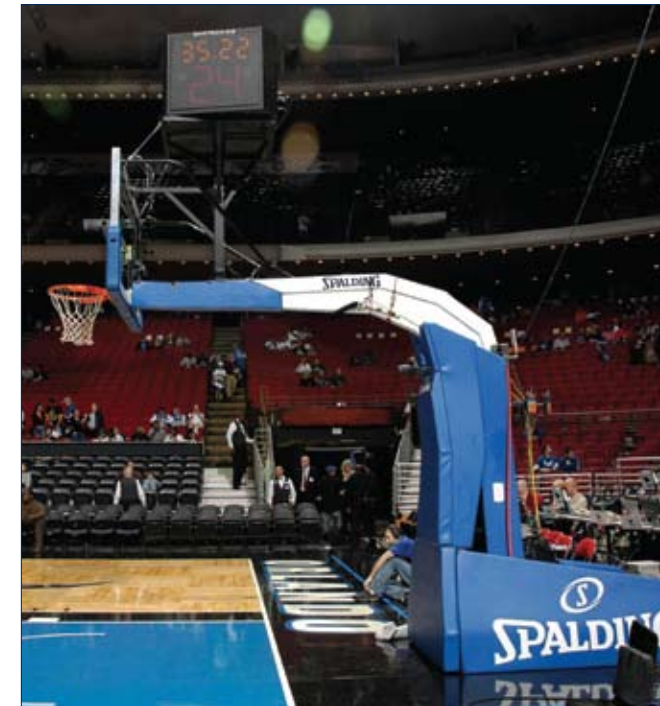

ORLANDO MAGIC
Orlando, FL

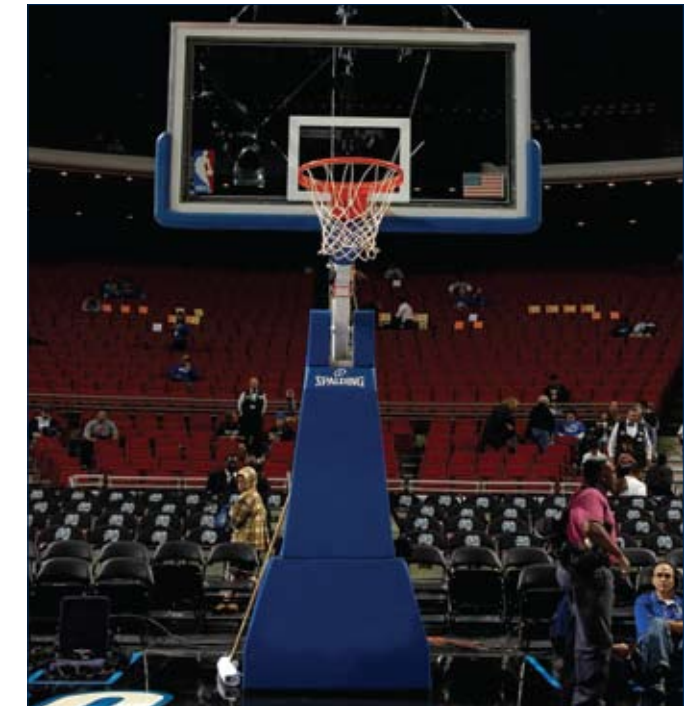

ORLANDO MAGIC
Orlando, FL

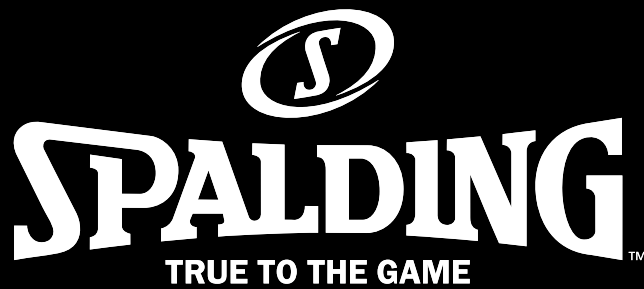

200 American Avenue | Jefferson, Iowa 50129
(toll free) 800.435.3865 | (phone) 515.386.3125
(fax) 515.386.8737 | www.spaldingequipment.com

The NBA and individual NBA member team identifications reproduced on this product are trademarks and copyrighted designs, and/or other forms of intellectual property, that are the exclusive property of NBA Properties, Inc. and the respective NBA member teams and may not be used, in whole or in part, without the prior written consent of NBA Properties, Inc. (c) 2008 NBA Properties, Inc. All rights reserved. All photos courtesy of NBA Photos.

The NBA DL and NBA DL team identifications are the trademarks and copyrighted designs, and/or other forms of intellectual property of NBA Development League, LLC. and may not be used, in whole or in part, without the prior written consent of NBA Development League, LLC. (c) 2008 NBA Development League, LLC. All Rights Reserved.

NCAA and FINAL FOUR are licensed by or trademarks of The National Athletic Association.

NFHS is a registered trademark of the National Federation of State High Schools.

All other trademarks are owned by Russell Corporation or its affiliate. © 2010 Russell Brand Corporation. All rights reserved.